

Cooking Collection

Instructions for Use
and
Warranty Details

Professional Series
Freestanding Ovens and Cooktops

Congratulations on the purchase of your new appliance. This appliance has been designed and manufactured to give you years of reliable performance.

For best results, carefully read the instructions on how to install your new appliance. Correct installation will avoid delays and unnecessary service calls.

Once installation is complete, read this booklet carefully and get to know the controls and the features of your new appliance.

We reserve the right to alter the specifications with no influence on the operation of the appliance. This instruction manual cannot be reason for a claim.

1. General information	5
1.1 Technical service	5
2. Warnings for safety and use	6
3. Installation	8
3.1 General warnings	8
3.2 Fitting the front moulding	9
3.3 Fitting the adjustable feet	9
3.4 Electric connection	10
3.5 Power consumption of the vitroceramic hob	12
3.6 Power consumption of the volcanic rock grill	12
3.7 Ventilation in rooms with gas appliances	12
3.8 Gas connection	13
3.9 Gas adjustments	14
3.10 Connecting to LPG	15
4. Final operations	16
4.1 Fixing the free-standing cooking hob	16
4.2 Levelling the cooker to the floor	16
5. Description of controls	17
5.1 The front panel	17
6. Using the cooking hob	23
6.1 Switching on the burners	23
6.2 Switching off the burners	23
6.3 Abnormal Operation	23
7. Using the deep fryer	24
7.1 Before switching on the deep fryer	24
7.2 How to fry	24
7.3 Indicative frying times	25
7.4 Switching off	25
8. Using the fry-top / steak grill	26
8.1 Before switching on the fry-top / steak grill	26
8.2 Switching on	26
8.3 Energy regulator table	26
8.4 Switching off	26
9. Using the volcanic rock grill	27
9.1 Before switching on the grill	27
9.2 Switching on	27
9.3 Energy regulator table	28
9.4 Switching off	28
10. Using the vitroceramic hob	29
10.1 General warnings	29
10.2 Switching on	29
10.3 Switching off	29

11. Using the ovens	30
11.1 General warnings	30
11.2 Drawer and storage compartment	30
11.3 Using the electric multifunction oven	30
11.4 Using the auxiliary oven with natural convection	32
11.5 Using the convection electric oven	33
11.6 Using the grill oven with natural convection	34
12. Cooking suggestions	35
12.1 Suggestions for using the hob burners correctly	35
12.2 Suggestions for using the deep fryer correctly	35
12.3 Suggestions for using the fry-top / steak grill correctly	35
12.4 Suggestions for using the volcanic rock grill correctly	35
12.5 Suggestions for using the vitroceramic hob correctly	36
12.6 Suggestions for using the oven correctly	36
13. Cleaning and maintenance	39
13.1 Cleaning stainless steel surfaces	39
13.2 Cleaning enamelled surfaces	39
13.3 Cleaning the knobs and the control panel	39
13.4 Cleaning the grids and burners	39
13.5 Cleaning the igniter plugs and thermocouples	40
13.6 Cleaning the deep fryer	40
13.7 Cleaning the fry-top / steak grill	40
13.8 Cleaning the volcanic rock grill	41
13.9 Cleaning the vitroceramic hob	41
13.10 Cleaning the oven	42
13.11 Replacing the oven light bulb	42
14. Special maintenance	43
14.1 Removing the oven door	43
14.2 Removing the side rack-holder frames	44
14.3 Removing and cleaning the inside oven fan	44

This user's manual is an integral part of the product purchased. The user must conserve the manual correctly so that it is always available for consultation during the use and maintenance of the product. Keep this user's manual for future reference. If the product is resold, the manual must be transferred to any subsequent owner or user of the product.

CLASSES OF APPLIANCES

The cooking appliances described in this operating manual belong to the following installation classes:

- **Class 1: non-flush-mounted** cooking appliance;



- **Class 2 – subclass 1:** cooking appliance **flush-mounted between two units**, made up of a single unit, but which can also be installed so that the side walls are accessible.

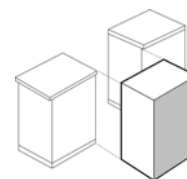

1. General information

1.1 Technical service



Before leaving the factory, this appliance has been tested and set up by qualified, specialist personnel, so as to guarantee the best operating results. Each repair or adjustment that may subsequently be necessary must be carried out with the utmost care and attention. We therefore recommend always contacting the Dealer where the appliance was purchased or your nearest Service Centre, specifying the type of problem and the appliance model.

2. Warnings for safety and use

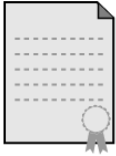

THIS MANUAL IS AN INTEGRAL PART OF THE APPLIANCE. IT SHOULD BE KEPT IN GOOD CONDITION AND CLOSE TO THE APPLIANCE FOR THE WHOLE LIFECYCLE OF THE COOKER. WE RECOMMEND READING THIS MANUAL AND ALL THE INDICATIONS IT INCLUDES VERY CAREFULLY BEFORE USING THE COOKER. IN CASE AN ADDITIONAL JETS KIT IS GIVEN AS ACCESSORY TO THE COOKER, WE RECOMMEND KEEPING AND PRESERVING IT. **THE INSTALLATION MUST BE CARRIED OUT BY AUTHORISED PERSON AND IN COMPLIANCE WITH CURRENT REGULATIONS IN FORCE.** THIS APPLIANCE IS ENVISAGED FOR DOMESTIC USE AND CONFORMS TO THE **AUSTRALIAN STANDARDS** CURRENTLY IN FORCE. THE APPLIANCE IS BUILT FOR CARRYING OUT THE FOLLOWING FUNCTION: **COOKING AND HEATING FOOD**; ANY OTHER USE IS TO BE CONSIDERED IMPROPER. **THE MANUFACTURER DECLINES ANY RESPONSIBILITY SHOULD THE APPLIANCE BE USED FOR PURPOSES OTHER THAN THOSE INDICATED.**

AT THE MOMENT OF PURCHASE, THE USER ASSUMES DIRECT RESPONSIBILITY FOR THE PRODUCT AND MUST THEREFORE MAKE SURE THAT, WITH NORMAL USE, NO INSTABILITY, DEFORMATION, BREAKAGE OR WEAR OCCURS OVER TIME THAT WOULD REDUCE PRODUCT SAFETY.

THIS PRODUCT IS DESIGNED AND MANUFACTURED TO OPERATE SAFELY AND DOES NOT POSE ANY DANGERS TO PEOPLE, ANIMALS, AND OBJECTS.



DO NOT SPRAY AEROSOLS IN THE VICINITY OF THIS APPLIANCE WHILE IT IS IN OPERATION.

WHERE THIS APPLIANCE IS INSTALLED IN MARINE CRAFT OR IN CARAVANS, IT SHALL NOT BE USED AS A SPACE HEATER.



DO NOT LEAVE ANY PIECES OF THE PACKING UNATTENDED IN THE HOME. SEPARATE THE VARIOUS PACKING MATERIALS AND DELIVER THEM TO THE NEAREST RECYCLING CENTRE.

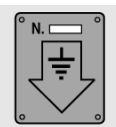

THE EARTH CONNECTION IS OBLIGATORY CONFORMING TO THE MODALITIES ENVISAGED BY THE SAFETY STANDARDS OF THE ELECTRICAL WIRING SYSTEM.

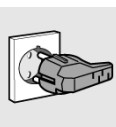

THE PLUG TO BE CONNECTED TO THE POWER SUPPLY CABLE AND THE RELATIVE SOCKET MUST BE THE SAME TYPE AND MUST COMPLY WITH CURRENT STANDARDS. AFTER INSTALLING THE APPLIANCE MAKE SURE THAT THE PLUG IS ACCESSIBLE TO ALLOW THE PERIODICAL CHECK-UP. **DO NOT PULL OUT THE PLUG BY PULLING THE CABLE.**



SHOULD THE GAS TAPS BE DIFFICULT TO ROTATE, LUBRICATE THEM USING A SPECIFIC PRODUCT FOR HIGH TEMPERATURES. **CONTACT THE TECHNICAL SERVICE FOR THIS OPERATION.**



IMMEDIATELY AFTER INSTALLATION, TEST THE APPLIANCE BRIEFLY BY FOLLOWING THE INSTRUCTIONS SHOWN BELOW. IN THE EVENT OF A MALFUNCTION, DISCONNECT THE APPLIANCE FROM THE MAINS AND CONTACT YOUR NEAREST TECHNICAL SERVICE CENTRE. **DO NOT ATTEMPT TO REPAIR THE APPLIANCE.**



EACH TIME YOU FINISH USING THE COOKING HOB, ALWAYS CHECK THAT THE CONTROL KNOBS ARE IN "ZERO" POSITION (OFF).



NEVER PUT INFLAMMABLE OBJECTS INTO THE OVEN: SHOULD IT BE ACCIDENTALLY SWITCHED ON, A FIRE MAY BREAK OUT. **IN THE EVENT OF A FIRE: CLOSE THE MAIN GAS SUPPLY AND CUT OFF THE ELECTRIC CURRENT.** DO NOT THROW WATER ON BURNING OR FRYING OIL. DO NOT STORE INFLAMMABLE OBJECTS OR AEROSOL CANS NEAR THE APPLIANCE AND DO NOT SPRAY NEAR THE BURNERS WHEN SWITCHED ON. DO NOT WEAR BAGGY CLOTHES OR ACCESSORIES THAT ARE NOT CLOSE TO THE BODY WHEN THE BURNERS ARE SWITCHED ON: SERIOUS INJURIES CAN BE CAUSED BY BURNING FABRIC. DO NOT STORE FLAMMABLE MATERIALS IN THE STORAGE DRAWER.



DO NOT REST SAUCEPANS THAT DO NOT HAVE A PERFECTLY SMOOTH, EVEN BASE ON THE COOKING HOB.

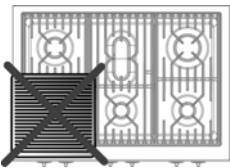

DO NOT USE RECEPTACLES OR STEAK GRILLS THAT EXCEED THE OUTER PERIMETER OF THE COOKING HOB.

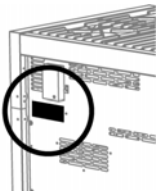

THE IDENTIFICATION PLATE WITH THE TECHNICAL DATA, SERIAL NUMBER AND THE MARK IS CLEARLY VISIBLE ON THE BACK OF THE APPLIANCE.
THE PLATE MUST NEVER BE REMOVED.



THE APPLIANCE SHOULD ONLY BE USED BY ADULTS. DO NOT ALLOW CHILDREN TO APPROACH OR PLAY WITH THE APPLIANCE. NEVER STORE ITEMS THAT CHILDREN MAY ATTEMPT TO REACH ABOVE THE APPLIANCE. THE HEATING UP OF SOME PARTS OF THE APPLIANCE AND OF THE USED PANS MAY BE A DANGER, SO DURING FUNCTIONING AND DURING ALL THE TIME NECESSARY FOR THE COOLING DOWN, TAKE CARE TO POSITION THE HOT PANS IN A WAY TO PREVENT BURNS OR OVERTURNING. AVOID LEAVING THE OVEN DOOR OPEN DURING FUNCTIONING OR IMMEDIATELY SOON AFTER THE SWITCHING OFF. AVOID TOUCHING THE HEATING ELEMENTS INSIDE THE OVEN AND GRILLS AS WELL.



RESTING OR SITTING ON THE OPEN OVEN DOOR, DRAWERS OR STORAGE COMPARTMENT CAN OVERTURN THE APPLIANCE, AND CONSEQUENTLY CAUSE HARM. THE DRAWERS HAVE A DYNAMIC CAPACITY OF 25 KG.



WHEN THE APPLIANCE IS DECOMMISSIONED, IT MUST BE DISPOSED OF IN A SUITABLE RECYCLING CENTRE. CUT OFF THE MAINS POWER CORD AFTER UNPLUGGING IT FROM THE WALL OUTLET, AND MAKE SAFE ANY COMPONENTS WHICH MIGHT BE DANGEROUS FOR CHILDREN (DOORS, ETC.).



The manufacturer declines any responsibility for damage incurred by persons or objects that is caused by not following the above guidelines or by tampering with any part of the appliance or by using non-original spare parts.



3. Installation

DIMENSIONS OF THE FREE-STANDING COOKING HOBS

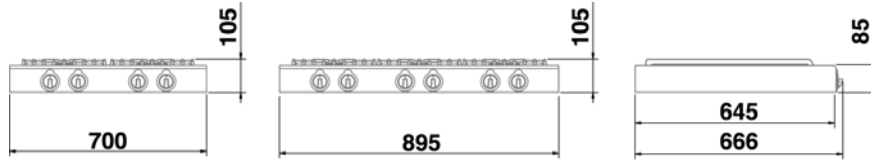

DIMENSIONS OF THE COOKING HOBS

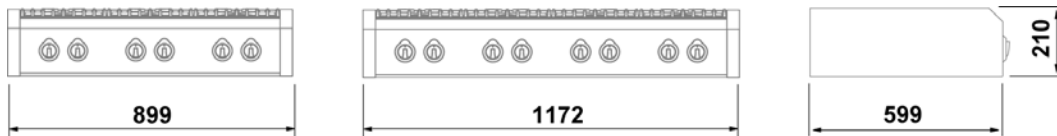

DIMENSIONS OF THE COOKERS

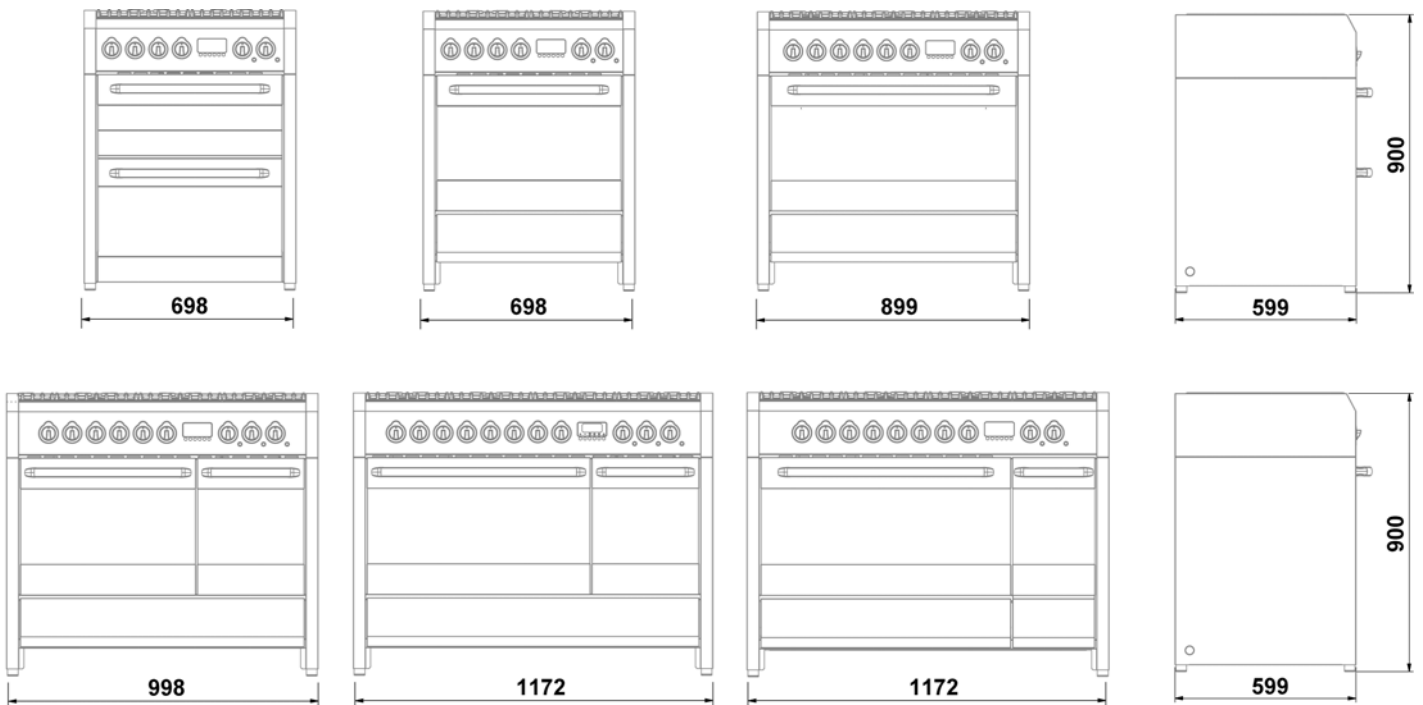

3.1 General warnings



This appliance shall be installed only by authorised personnel and in accordance with the manufacturer's installation instructions, local gas fitting regulations, municipal building codes, water supply regulations, electrical wiring regulations, AS 5601/AG 601 - Gas Installations and any other statutory regulations. Before using the appliance, remove the protective plastic on the control panel, stainless steel parts, etc...

The manufacturer declines any responsibility for damage incurred by persons, animals or objects that is caused by not following the above guidelines (cfr. chapter "2. Warnings for safety and use").

The technical data is indicated on the plate located on the back of the appliance. The adjustment conditions are shown on a label applied to the packing and the appliance.

Do not use the oven door handle for handling the appliance, or for removing the appliance from the packing.



3.2 Fitting the front moulding

For the **70 cm model with double oven**, a front moulding is included as standard supply to complete the aesthetic lines of the cooker.



Before turning the cooker over, we recommend removing all the parts that are not stably attached to it, in particular the cooking hob grids and burners. To lighten the weight of the cooker, the accessories inside the oven may also be removed, thereby preventing accidental damage during the overturning operation.

To assemble, proceed as follows:

- Tilt the cooker backwards.
- Align the moulding **A** with the mounting position as shown in the illustration.
- Apply the moulding until it fits into the mounting position.
- Pull the moulding downward so that it hooks onto the 4 pins **B** (2 for each end) present on the cooker.

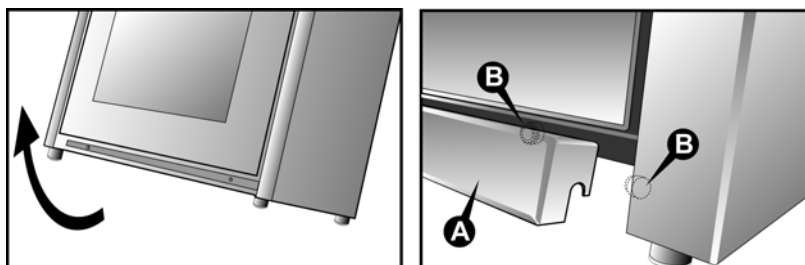

3.3 Fitting the adjustable feet



Before turning the cooker over, we recommend removing all the parts that are not stably attached to it, in particular the cooking hob grids and burners. To lighten the weight of the cooker, the accessories inside the oven may also be removed, thereby preventing accidental damage during the overturning operation.

The cooker is delivered with the feet removed. Before moving and hooking up the cooker, take the feet from the packing and screw them onto the cooker. This can be done in one of two ways:

- A** Lifting the cooker off the floor.
- B** Laying the cooker on its back.

The **final regulation** of the feet to level the cooker to the floor will be done **after the gas and electric hook-ups have been made**.

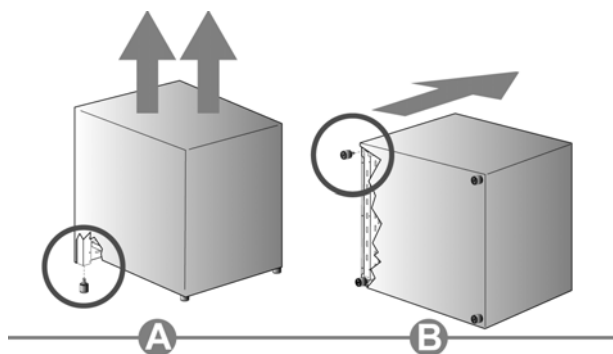

*Should it be necessary to drag the cooker, **screw the feet in completely and carry out the final regulation only when the other operations are completed**.*



3.4 Electric connection



Make sure that the voltage and the size of the mains correspond to the specifications shown on the plate located on the back of the appliance.

The plate must never be removed.



The plug at the end of the power supply cable and the wall socket must be the same type and must comply with current electric standards. Check that the mains is adequately earthed. Once the appliance has been installed make sure that the plug is accessible to allow the periodical check-up.



Prepare an omni-polar cutoff device on the power supply line of the appliance with a contact opening distance equal to or more than **3 mm**, located in a convenient position near the appliance.

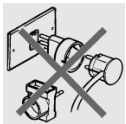

Do not use reducers, adapters or shunts.

Before making the electric connection, make sure of the efficiency of the earthing.

Make sure that the relief valve and the home wiring system are able to withstand the appliance load.

The yellow/green earth cable must not be subject to cutoffs.

The electric cable must not come into contact with parts whose temperature is more than **50°C** higher than room temperature.

3.4.1 Electric power cable section

According to the type of power supply, use a cable that conforms to the following table.

Running at 415 Vac 3Ph N (models connected according to DIAGRAM "A"): use a pentapolar cable type H05RR-F/H05RN-F (cable measuring 5 x 2.5 mm²).

Running at 240 Vac 1Ph N (models connected according to DIAGRAM "B"): up to 10.44 MJ use a tripolar cable type H05RR-F/H05RN-F (cable measuring 3 x 1.5 mm²); between 10.44 MJ and 19.44 MJ use a tripolar cable type H05RR-F/H05RN-F (cable measuring 3 x 2.5 mm²).

The end to be connected to the appliance must have the earth wire (yellow-green) at least **20 mm** longer.

The cable type **H05RN-F** is to be used for the models with fryer, while cable type **H05RR-F** for those without fryer.

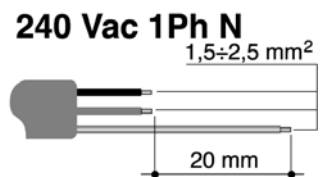
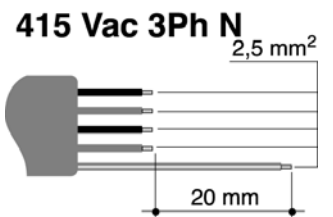



3.4.2 Type of power supply

It is possible to obtain different connections according to the voltage, simply by moving the unconnected cable ends on the terminal board as shown in the following diagrams. According to the model, consult the table "CONNECTION TO THE TERMINAL BOARD".

DIAGRAM	CONNECTION TO THE TERMINAL BOARD		
"A"	MODEL	POWER kW	CURRENT DRAW (amps)
<p>415 Vac 3Ph N</p>	COOKING HOB 4 / 6 / 8 BURNERS	0,006	0,025
	COOKING HOB 4 / 6 BURNERS + B / T / C	2,4	10
	COOKING HOB 4 / 6 BURNERS + F	2,2	9
	COOKING HOB 4 / 6 BURNERS + G	2,5	10
	COOKING HOB 4 BURNERS + B / T + C	4,8	20
	COOKING HOB 4 BURNERS + B / T + F	4,6	19
	COOKING HOB 4 BURNERS + B / T + G	4,9	20
	VITROCERAMIC HOB (4 HEATING ELEMENTS)	7,6	31
	VITROCERAMIC HOB (5 HEATING ELEMENTS)	9,8	40
	COOKER 4 BURNERS (1 OVEN)	2,2	9
	COOKER 6 / 8 BURNERS (1 OVEN)	2,9	12
	COOKER 4 / 6 BURNERS (1 OVEN) + B / T / C	5,3	22
	COOKER 4 / 6 BURNERS (1 OVEN) + F	5,1	21
	COOKER 4 / 6 BURNERS (1 OVEN) + G	5,4	22
	COOKER 4 BURNERS (1 OVEN) + B / T + C	7,7	32
	COOKER 4 BURNERS (1 OVEN) + B / T + F	7,5	31
COOKER 4 BURNERS (1 OVEN) + B / T + G	7,8	32	
COOKER VITROCERAMIC HOB (1 OVEN) (4 HEATING ELEMENTS)	9,8	40	
COOKER VITROCERAMIC HOB (1 OVEN) (5 HEATING ELEMENTS)	12,7	52	
COOKER 6 BURNERS (2 OVENS)	3,9	16	
COOKER 8 BURNERS (2 OVENS)	4,6	19	
COOKER 4 BURNERS (2 OVENS)	4,7	19	
COOKER 4 BURNERS (2 OVENS) + B / T / C	6,3	26	
COOKER 4 BURNERS (2 OVENS) + F	6,1	25	
COOKER 4 BURNERS (2 OVENS) + G	6,4	26	
COOKER 6 BURNERS (2 OVENS) + B / T / C	7,0	29	
COOKER 6 BURNERS (2 OVENS) + F	6,8	28	
COOKER 6 BURNERS (2 OVENS) + G	7,1	29	
COOKER 4 BURNERS (2 OVENS) + B / T + C	9,4	39	
COOKER 4 BURNERS (2 OVENS) + B / T + F	9,2	38	
COOKER 4 BURNERS (2 OVENS) + B / T + G	9,5	39	
COOKER VITROCERAMIC HOB (2 OVENS) (5 HEATING ELEMENTS)	13,7	56	
COOKER VITROCERAMIC HOB (2 OVENS) (4 HEATING ELEMENTS)	12,3	51	
B = STEAK GRILL			
T = FRY-TOP			
C = VITROCERAMIC GRIDDLE			
F = DEEP FRYER			
G = GRILL			

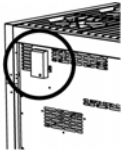

3.4.3 Replacing the electric cable

To replace the electric cable, it is necessary to access the terminal board. It is located on the back of the appliance, at the top left, as shown in the figure.

To replace the cable, proceed as follows:

- open the terminal board box;
- unscrew the screw **A** that locks the cable;
- loosen the screw contacts and replace the cable with one of the same length that corresponds to the specifications in the table in section "3.4.1 Electric power cable section";
- the "yellow-green" earth wire must be connected to the terminal \oplus and must be approximately **20 mm** longer than the line cables;
- the neutral "blue" wire must be connected to the terminal marked with the letter **N**;
- the line wire must be connected to the terminal marked with the letter **L**.

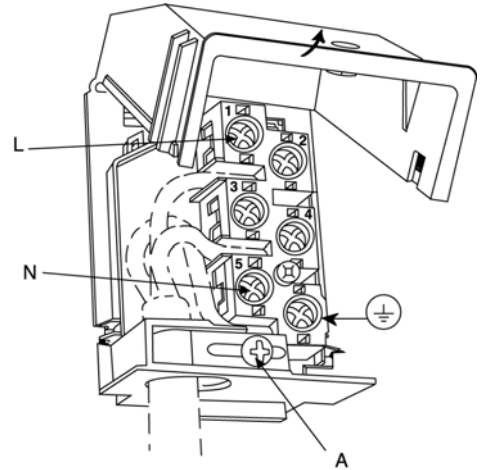

3.5 Power consumption of the vitroceramic hob

The vitroceramic hob has different power consumptions depending on the type of heating element used. The diagram shows the values of the power consumed.

In the envisaged cases, the first numeric value refers to the total power, whereas the value that follows the symbol "/" refers to the inside diameter, with the exception of the central heating element, whose value that follows "/" refers to the outer diameter.

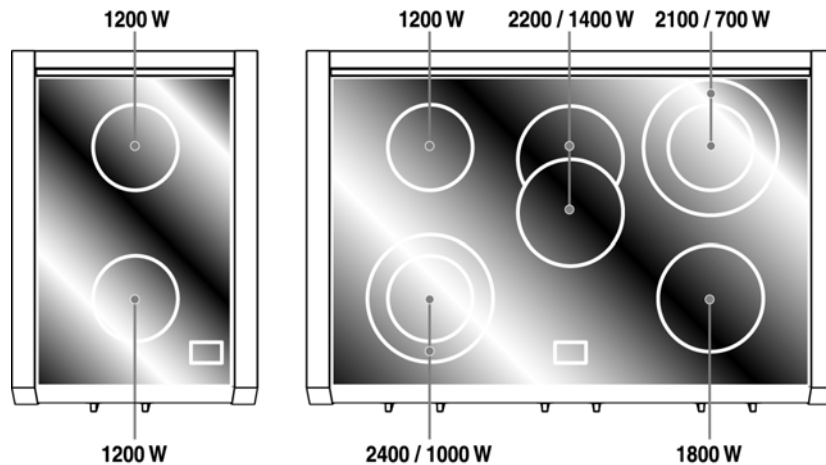

3.6 Power consumption of the volcanic rock grill

The volcanic rock grill has a consumption of **2500W**. This appliance must therefore be installed where this power consumption can be ensured in total safety.

3.7 Ventilation in rooms with gas appliances

This appliance is not connected to an exhaust device for products of combustion. Ventilation must be in accordance with AS5601/AG 601 - Gas Installations. In general, the appliance should have adequate ventilation for complete combustion of gas, proper flueing and to maintain temperature of immediate surroundings within safe limits. Pay particular attention to standards applied to room aeration.





This appliance can only be installed in ventilated rooms, according to current standards, so as to allow, with openings onto external walls or appropriate ducts, for correct natural or forced ventilation that **permanently and sufficiently** ensures both the air intake necessary for correct combustion and the expelling of vitiated air. It is recommended that the appliance have a rangehood fitted directly above or ceiling fan in close proximity to the appliance.



In all other cases, i.e. when other gas appliances are present in the same room, or, if it is not possible to have natural direct ventilation, it is necessary to create natural, indirect ventilation or forced ventilation: **for this type of operation, it is necessary to contact a authorised person for installing and creating the ventilation system in strict compliance with the guidelines set out in current standards.**

The openings should be positioned so as not to allow the formation of any unpleasant air current for the occupants. Furthermore, it is forbidden to use flues already used by other appliances to expel products of combustion.

3.8 Gas connection



Gas-powered devices for home use, which are not connected to a conduit for the evacuation of combustion products, must not cause a concentration of carbon monoxide that could pose a health risk to the persons exposed in relation to the time of exposure.

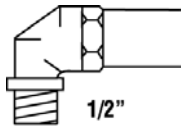

We recommend checking that the appliance is properly set up for the type of gas distributed. The connection to the gas pipes must be made in a workmanlike manner, in compliance with current standards that prescribe the installation of a safety tap at the end of the pipe. The Gas Connection is male 1/2" BSP and is situated at the left hand, top rear of the appliance, 74mm from the side and 700mm from the floor (cookers) or 25mm from the underside (cooktops). The appliance is factory set for Natural gas. The test point pressure should be adjusted to 1.00kPa with the Wok and Semi-Rapid burners operating at maximum on 120cm models and the Wok burner operating at maximum on 90cm models.

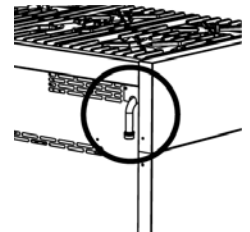

For propane a pressure regulator set to provide a supply pressure of 2.75kPa conforming to standards regulations in force should be fitted. The seals must conform to standards regulations in force. Fit the test point assembly supplied with the appliance to the gas connection when installing for use with Propane Gas. Once the gas has been connected, check the seal of the unions with a soap and water solution.

It is possible to connect the gas in the following ways:

- using iron or copper rigid pipe as specified in AS5601 table 3.1;
- using a Plumbezy flexible hose, AGA approval number 6196, 10mm ID, class D and between 1-1.2m long in accordance with AG601 for a "high level connection". For cookers supplied with a flexible hose the restraining chain fitted to the rear of the cooker must be fixed to the wall as follows.
 1. Supply fixing points on either side of the cooker (vertically in line with the chains attached) at approximately 100mm above floor level.
 2. Firmly secure the chains at these points.
 3. Supply similar fixing points at approximately 700mm above floor level using open hooks.
 4. Loop the chains over these hooks to prevent the cooker from accidentally tilting.
 5. Removing the chains from the hooks enables the cooker to be pulled out for service. Ensure that the chains prevent stress on the hose assembly while the cooker is in this position.

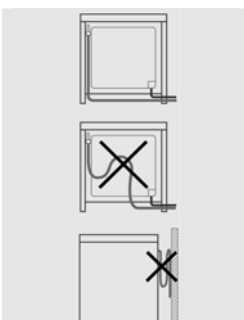

- Do not allow the pipes to be constricted or crushed;
- Pipes must not be subject to tractive force or torsional stress;
- Do not allow the pipes to come into contact with cutting or sharp edges, etc...
- Do not allow the pipes to come into contact with parts that can reach temperatures of **70°C** above room temperature;
- Make sure the entire length of the pipes can be inspected.
- Do not use the Natural Gas Regulator supplied with the appliance for Propane Gas.



The unit must be coated in heat-resistant material (**minimum 90°C**). If the appliance is installed close to other units, the minimum space suggested in the following diagram must be left.

Any adjoining wall surface situated within 200mm from the edge of any hob burner must be a suitable non-combustible material for a height of 150mm for the entire length of the hob. Any combustible construction above the hotplate must be at least 600mm above the top of the burner and no construction shall be within 450mm above the top of the burner.

Where the distance from the edge of any burner to a horizontal surface is less than 200mm, the surface must be either: 10mm (min) below the level of the hob, or have the vertical component of the surface suitably covered with a non-combustible material as specified in AS 5601 - AG 601.

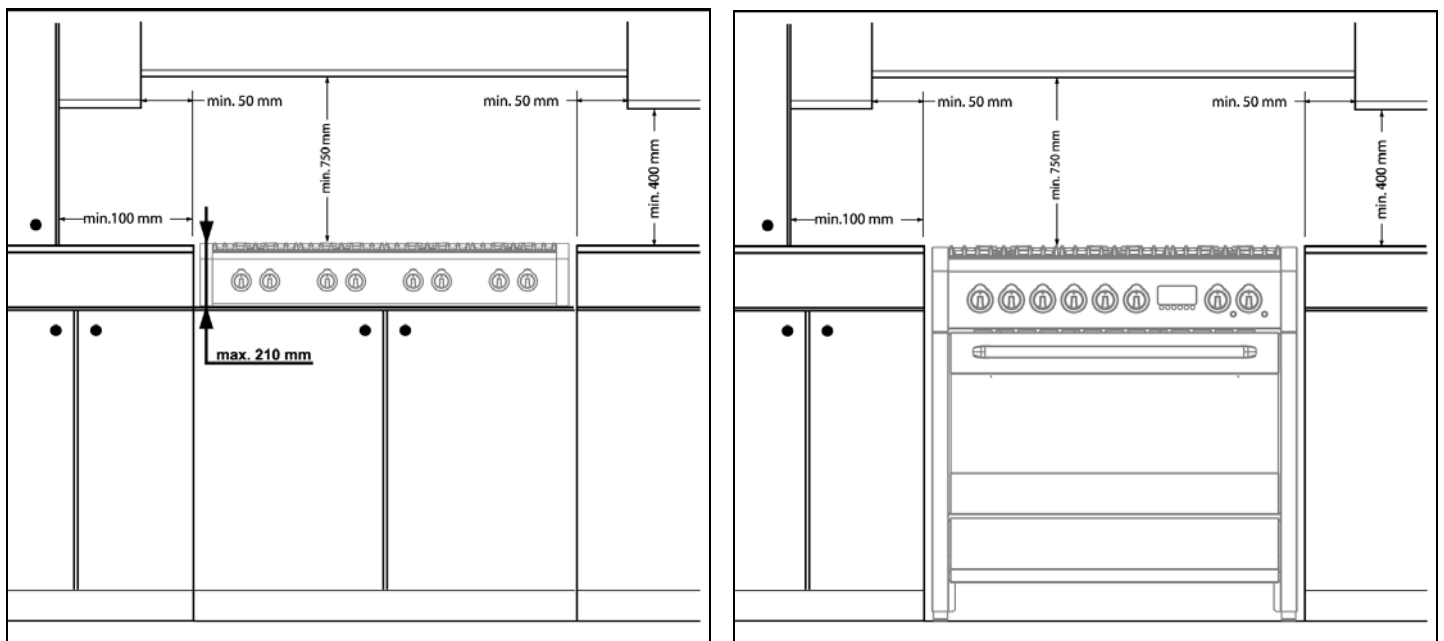

3.9 Gas adjustments

For cooktops, the Data Label is located on the underside of the appliance. A duplicate label is supplied to adhere in an accessible area adjacent to the appliance. For cookers, the label is situated in the appliance drawer. This appliance is suitable for Natural Gas and Propane; ensure that the available gas supply matches the Data Label.

If the cooking appliance is set up for a different type of gas than that available, its injectors must be replaced, the minimum flow regulated and the rubber-holder changed. In order to replace the injectors in the cooking hob, it is necessary to carry out the following operations:

- remove the grids;
- remove the burners and burner caps (**Fig. A**);
- take out the injector (**Fig. B**) and replace it with one suitable for the new type of gas (see "**GENERAL INJECTORS TABLE**");
- replace the gas label (on the rear of the appliance) with the new one provided with the injectors kit;
- refit all parts by following the disassembly instructions in reverse order and taking care to position the burner cap correctly on the burner.

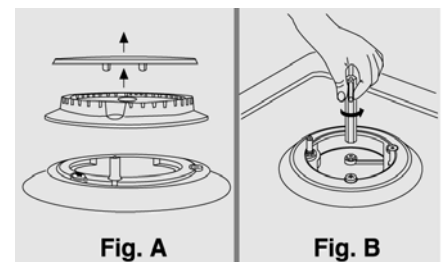



3.9.1 Minimum flow of valved cooking hob taps

- Switch on the burner and turn the control knob towards the minimum flow position ;
- remove the knob;
- using a screwdriver, adjust the internal screw **Z** until the correct low flame is obtained;
- refit the knob.

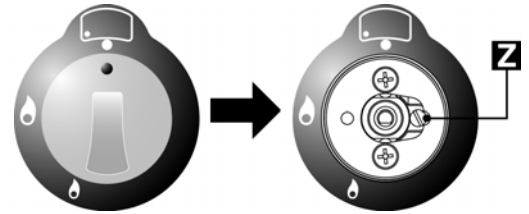

3.9.2 Minimum flow of non-valved cooking hob taps

- Switch on the burner and turn the control knob towards the minimum flow position ;
- remove the knob;
- insert a small screwdriver into the rod of the tap and adjust the internal screw **Z** until the correct low flame is obtained;
- refit the knob.

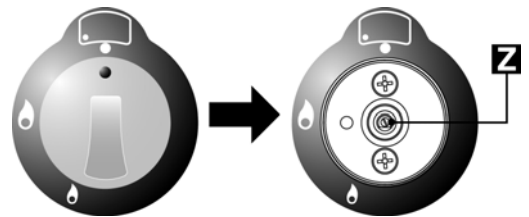

- *Unscrew the adjustment screw **Z** to increase the flow, or tighten it to reduce the flow.*
- *The adjustment is correct when the low flame measures approximately **3 or 4 mm**.*
- *For **propane** the adjustment screw should be tightened all the way.*
- *When changing quickly from maximum to minimum flow and vice versa **make sure that the flame does not go out**.*

GENERAL INJECTORS TABLE

TYPE OF GAS	kPa	NOZZLE NO.	BURNERS POSITION TYPE	CONSUMPTION
				MAX.
NATURAL GAS	1.00	1.50	RAPID	11.2
		1.20	SEMI RAPID	7.2
		0.90	AUXILIARY	4.1
		1.60	TRIPLE-RING	12.7
		1.20	FISH KETTLE	7.2
LPG	2.75	0.95	RAPID	11.5
		0.73	SEMI RAPID	7.0
		0.53	AUXILIARY	3.6
		1.00	TRIPLE-RING	12.7
		0.75	FISH KETTLE	7.3

3.10 Connecting to LPG



Use a pressure regulator and connect to the cylinder in compliance with the guidelines set out in standards regulations in force.

When converting from Natural Gas to Propane ensure that the NG regulator is removed and replaced with the Test Point Assembly. A gas regulator suitable for a supply pressure of 2.75kPa should be part of the gas tank supply and should be adjusted with the Wok burner operating at maximum. Replace the old data plate with one which is suitable for the type of gas for which the appliance has been regulated.



4. Final operations

4.1 Fixing the free-standing cooking hob

Once the gas pipes and electric cables have been connected, the free-standing cooking hob must be fixed to the support unit using the brackets **A** provided and the four screws **B**.



Make sure that the gas pipes and electric cables are not crushed or obstructed.

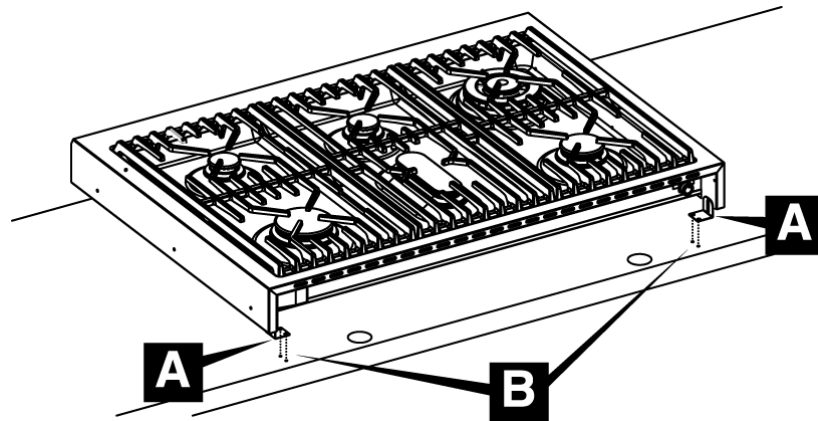

4.2 Levelling the cooker to the floor

After having made the electrical and gas hook-ups, level the cooker to the floor using the adjustable feet that were previously screwed onto the bottom of the cooker.



Should it be necessary to drag the cooker, screw the feet in completely and carry out the final regulation only when the other operations are completed.



Check all connections for gas leaks with soap and water. DO NOT use a naked flame for detecting leaks. Ignite all burners to ensure correct operation of gas valves, burners and ignition. Turn gas taps to low flame position and observe stability of the flame. When satisfied with the hotplate, please instruct the user on the correct method of operation. In case the appliance fails to operate correctly after all checks have been carried out, refer to the authorised service provider in your area.



5. Description of controls

5.1 The front panel

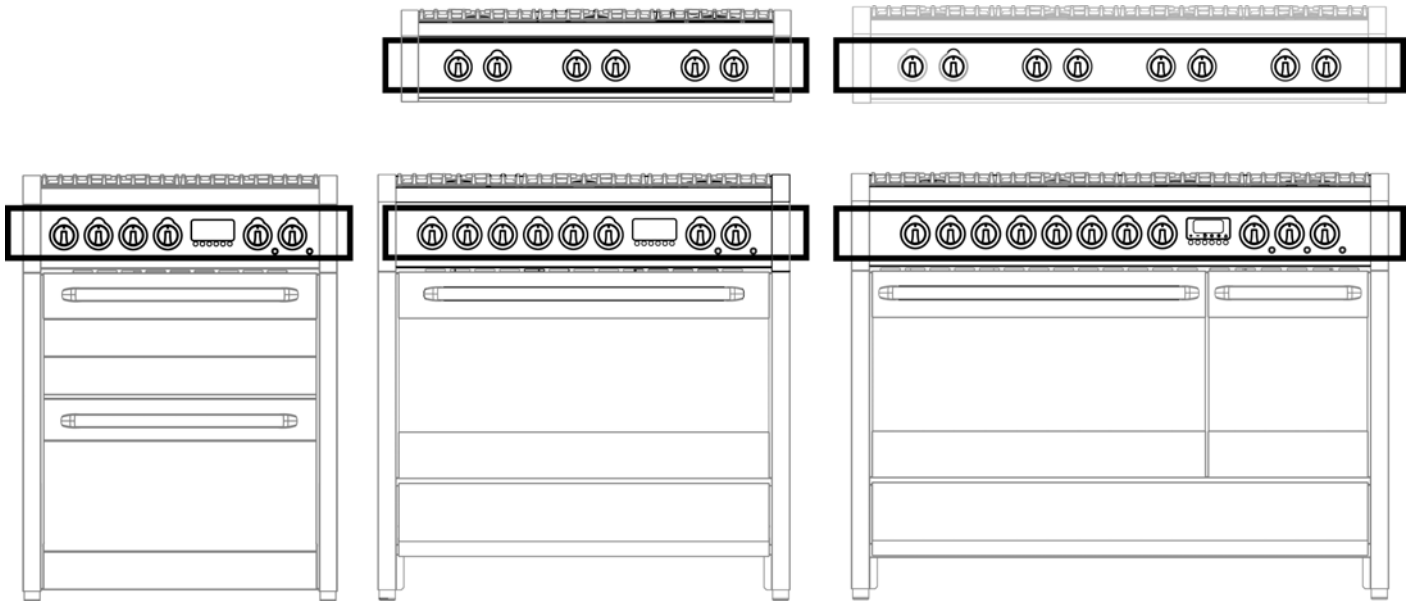

All the commands and controls for the cooking hob and oven are on the front panel.

CONTROL PANEL













DESCRIPTION OF HOB BURNER KNOB

The flame is lit by simultaneously pressing and turning the knob anticlockwise to the low flame symbol .

To regulate the flow of the flame, turn the knob to between the maximum  and minimum  settings. Turn off the burner by returning the knob to position .



LAYOUT OF BURNERS – Description of symbols

	REAR LEFT		REAR RIGHT
	REAR CENTRE LEFT		REAR CENTRE RIGHT
	CENTRE FRONT		CENTRE REAR
	FRONT CENTRE LEFT		FRONT CENTRE RIGHT
	FRONT LEFT		FRONT RIGHT



DESCRIPTION OF DEEP FRYER KNOB

The knob of the thermostat that controls the temperature of the heating element can be adjusted between **0°** and **200°C**. There are also two warning lights: the **red light** signals the deep fryer is working; the **orange light** switches on while the appliance is heating. When the preset temperature is reached, the **orange light** switches off. If the temperature of the oil should decrease while frying, the appliance automatically begins to heat and the **orange light** switches on until the temperature set on the thermostat knob is reached.

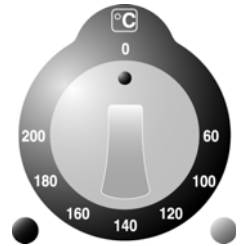

DESCRIPTION OF FRY-TOP / STEAK GRILL AND GRILL KNOB

FRY-TOP/STEAK GRILL: is equipped with **differentiated heating**. The entire cooking surface can be used, or only one of the two halves, front or rear. The knobs that regulate the energy individually control the temperature of the two heating elements. A **red light** indicates that the appliance is heating.

GRILL: two warning lights give essential information on how the appliance is working. The **orange light** switches on to indicate that the appliance is powered (ON). A **red light** indicates that the heating element is heating up.



LAYOUT OF HEATING ELEMENTS - Description of symbols



REAR



FRONT

DESCRIPTION OF TIMER KNOB (DEEP FRYER AND GRILL)

A spring-loaded **timer** with bell makes checking the frying time easier. Turn the knob all the way clockwise to wind the timer. It is possible to set the required time up to a maximum of **60 min**. The bell rings briefly when the preset time has elapsed. The timer has no effect on the heating of the deep fryer or the grill.

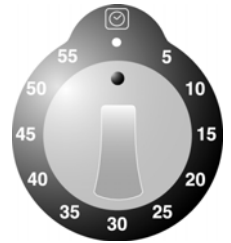

DESCRIPTION OF VITROCERAMIC HOB KNOBS

Besides the normal knobs that regulate the energy, the vitroceramic hob is equipped with knobs for **differentiated heating**. Settings from **1** to **11** control the heating of the internal element, setting the knob to the symbol ● the outer element also operates.



LAYOUT OF HEATING ELEMENTS - Description of symbols



REAR LEFT



FRONT LEFT



CENTRAL



REAR RIGHT



FRONT RIGHT



DESCRIPTION OF ELECTRIC OVEN KNOBS

The electric oven is controlled by two knobs: **function switch knob** and **thermostat knob**. They allow you to choose the most suitable type of heating for different cooking requirements, by switching on the heating elements appropriately and setting the required temperature (from **50°C** to **MAX**).

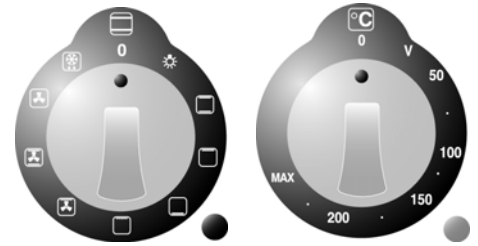

The **V** setting on the thermostat knob operates the oven fan.

Below the oven knobs there are two warning lights: the **red light** signals the oven is working; the **orange light** indicates that the preset temperature has been reached. The **orange light** switches on and off to indicate when the heating automatically kicks in to maintain the temperature inside the oven at the level set on the thermostat knob.

The oven has an **internal light**. The light is always on while the oven is working: it can be switched on while the oven is off, for cleaning purposes, by turning the function switch knob to the symbol ☀

DESCRIPTION OF SYMBOLS ON FUNCTION SWITCH KNOB

	SWITCH ON LIGHT INSIDE OVEN		GRILL-FAN ELEMENT
	UPPER AND LOWER HEATING ELEMENTS		UPPER AND LOWER HEATING ELEMENTS – FAN
	UPPER HEATING ELEMENT		HEATING ELEMENT-CONVECTION
	LOWER HEATING ELEMENT		DEFROST
	GRILL ELEMENT		

DESCRIPTION OF AUXILIARY ELECTRIC OVEN KNOB

Some cooker models are equipped with an auxiliary electric oven with natural convection, controlled by a single knob. This allows the user to choose the most suitable type of heating for different cooking requirements, by switching on the heating elements appropriately and setting the required temperature (from **60** to **MAX**). Using the same knob it is also possible to set the functions described in the table.

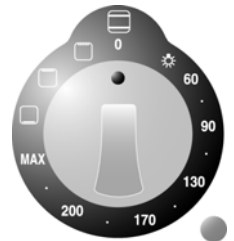

Below the auxiliary oven knob there is an **orange light**, which indicates when the oven has reached the set temperature. The **orange light** switches on and off to indicate when the heating automatically kicks in to maintain the temperature inside the auxiliary oven at the level set on the control knob.

The auxiliary oven has an **internal light**. The light is always on while the oven is working: it can be switched on while the oven is off, for cleaning purposes, by turning the function switch knob to the symbol ☀.

DESCRIPTION OF SYMBOLS ON AUXILIARY ELECTRIC OVEN KNOB

	SWITCH ON LIGHT INSIDE OVEN		UPPER HEATING ELEMENT
60÷MAX	UPPER AND LOWER HEATING ELEMENTS		GRILL ELEMENT + SPIT
	LOWER HEATING ELEMENT		



DESCRIPTION OF GRILL OVEN KNOB



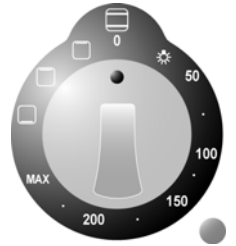

The electric oven, equipped with function grill with natural convection, is controlled by a single knob. By positioning the knob appropriately and by setting the required temperature, both upper and lower heating elements will switch on. It is possible to set one of the functions described in the table, but in this case the temperature of the chosen heating element will be automatically set to the **MAX** temperature value.



Below the grill oven knob there is an **orange light**, which indicates when the oven has reached the set temperature. The **orange light** switches on and off to indicate when the heating automatically kicks in to maintain the temperature inside the grill oven at the level set on the control knob.

The grill oven has an **internal light**. The light is always on while the oven is working: it can be switched on while the oven is off, for cleaning purposes, by turning the knob to the symbol .

DESCRIPTION OF SYMBOLS

	SWITCH ON LIGHT INSIDE OVEN		UPPER HEATING ELEMENT
50÷MAX	UPPER AND LOWER HEATING ELEMENTS		GRILL ELEMENT
	LOWER HEATING ELEMENT		

DESCRIPTION OF CONVECTION OVEN KNOB

The convection oven is controlled by a single knob. This allows the user to choose the most suitable type of heating for different cooking requirements by setting the required temperature value (from **50°C** to **MAX**).

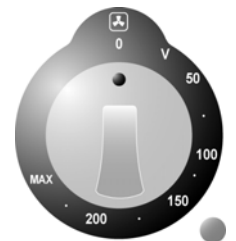

Turning the knob to the **"V"** position activates the motorized fan, which aids in the thawing of frozen foods by recirculating the air inside the oven.

Below the convection oven knob there is an **orange light**, which indicates when the oven has reached the set temperature. The **orange light** switches on and off to indicate when the heating automatically kicks in to maintain the temperature inside the convection oven at the level set on the control knob.

The oven has an **internal light**. The light is always on while the oven is working: it can be switched on while the oven is off, for cleaning purposes, by turning the knob to the symbol **"V"**.



DESCRIPTION AND USE OF THE END OF COOKING DISPLAY ON THE ELECTRIC OVEN

The end of cooking display electronically checks the operation of the oven. Programming the display allows the user to set the oven to switch on and off at set times.



	TIMER BUTTON
	COOKING TIME BUTTON
	END OF COOKING BUTTON
	MANUAL OPERATION BUTTON
-	DECREASE VALUE BUTTON
+	INCREASE VALUE BUTTON

SETTING THE TIME

When using the oven for the first time, or after a power cut, the display flashes regularly indicating **0:00**.

Press button to stop the flashing. Press the value variation buttons **-** or **+** **within 5 seconds** to increase or decrease by one minute at a time. Press one of the two value variation buttons until the current time appears.



Before setting the end of cooking display, it is necessary to select the required function and temperature.

SEMIAUTOMATIC COOKING

This setting automatically switches off the oven at the end of the cooking.

Press button and the display lights up showing the figures **0:00**; hold down and press at the same time the value variation buttons **-** or **+** to set the cooking time.

Release the button to begin the count of the programmed cooking time and the display shows the current time together with symbols **AUTO** and .

AUTOMATIC COOKING

This setting switches the oven on and off automatically.

Press button and the display lights up showing the figures **0:00**; hold down and press at the same time the value variation buttons **-** or **+** to set the cooking time.

Press button to display the sum of the current time plus the cooking time: hold down and press at the same time the value variation buttons **-** or **+** to set the end of cooking time.

Release the button to begin the programmed count and the display shows the current time together with symbols **AUTO** and .



After the setting, press button to see the remaining cooking time. Press button to see the end of cooking time.

END OF COOKING

At the end of the cooking, the oven switches off automatically and at the same time an intermittent bell rings. After deactivating the bell, the display once again shows the current time together with symbol , which signals the oven has returned to manual conditions.



ADJUSTING THE VOLUME OF THE BELL

The volume of the bell can be varied (on 3 levels) while it is operating by pressing button .

DEACTIVATING THE BELL

The bell automatically stops ringing after **seven minutes**. It is possible to deactivate it manually by pressing button .



After pressing button the oven begins to operate once again: to switch it off, turn the function switch knob and the thermostat knob to "0".

It is also possible to deactivate the bell by pressing any one of the function buttons. The oven switches off regardless of the function or set temperature and the **AUTO** symbol flashes. To stop the **AUTO** symbol flashing, press button , turn the function selector switch and thermostat to "0".

TIMER

The end of cooking display can also be used as a simple timer.



Using the display as a timer does not interrupt the operation of the oven at the end of the set time.

Press button and the display shows the figures ; hold down and press at the same time the value variation buttons or . Release the button to begin the programmed count and the display shows symbols and .



After programming the timer, the display once more shows the current time. To display the time remaining, press button .



Setting inconsistent values is logically prevented (e.g. the end of cooking display does not accept a contrast between an end of cooking time and a longer cooking time).

DELETING SET DATA

With the program set, hold down the button of the function you wish to delete while at the same time reaching value with the value variation buttons or . Deleting the cooking time is interpreted by the display as the end of the cooking.

MODIFYING SET DATA

The data set for cooking can be modified at any moment by holding down the button of the function and at the same time pressing the value variation buttons or .



6. Using the cooking hob



Make sure that the flame caps, the burner caps and the grids are fitted correctly.



During normal operations, the appliance heats up considerably. Caution should therefore be used. **Do not allow children to approach the appliance.** Do not leave the cooking hob unattended while it is on.

6.1 Switching on the burners



All the hob burner knobs have the following symbols:

- tap closed
- 🔥 high flame
- 🔥 low flame

The low flame setting is found by turning the knob anticlockwise all the way. All intermediate settings must be selected between the high flame and low flame, **never between high flame and closed.**

6.1.1 One-touch lighting

The hob burners are equipped with a "one-touch" lighting system. To switch on one of the burners, press the knob corresponding to the required burner and turn it anticlockwise to the low setting 🔥. Hold down the knob to activate the automatic "one-touch" lighting system. When the burner is on, hold down the knob for approximately **10 seconds**, to allow the safety valve to open. In the event of a power cut, the burner can also be lit with a match (see section "6.1.2 Manual lighting").



Should the burner switch off accidentally, the safety thermocouple blocks the gas flow, even when the tap is open.



Appliances not equipped with safety valve: it is not necessary to hold down the knob (the burner is immediately operative). Take care, however, as **if the flame should go out accidentally**, gas will continue to come out of the burner.

The device should not be activated for longer than **15 seconds**. If after that time it fails to operate stop pressing the knob, open the window and **wait 1 minute** before trying again. In case the flame goes out accidentally turn off the knob and do not try to switch on the burner for at least **1 minute**.

6.1.2 Manual lighting

To light one of the burners, move a lit match towards the burner, press the corresponding knob and turn it anticlockwise to the minimum setting 🔥. Release the knob.

6.2 Switching off the burners

At the end of the cooking, return the knob to position ●.

6.3 Abnormal Operation

Any of the following are considered to be abnormal operation and may require servicing:

- Yellow tipping of the hob burner flame.
- Sooting up of cooking utensils.
- Burners not igniting properly.
- Burners failing to remain alight.
- Burners extinguished by cupboard doors.
- Gas valves, which are difficult to turn.

In case the appliance fails to operate correctly, contact the authorised service provider in your area.



7. Using the deep fryer



During normal operations, the surface of the deep fryer heats up considerably. **Do not allow children to approach the deep fryer.** Do not leave the deep fryer unattended while it is on. Oil or fat in bad condition may burst into flames.

7.1 Before switching on the deep fryer

The first time it is used, the deep fryer may develop an acrid or burnt smell caused by oily residue from manufacturing that may give unpleasant odours or flavours to fried food. To eliminate this problem, clean the vat, basket and heating element before use.

Proceed as follows:

- wash the basket in warm water and detergent;
- pour warm water into the deep fryer vat and add detergent for stainless steel surfaces;
- carefully wash the vat and the heating element;
- lift the heating element upwards, rinse and dry;
- lock the heating element by moving the lock system **S** towards the left as shown in the figure;
- remove the frying vat, rinse away the soapy water with running water;
- dry the vat and return it to its working position;
- release the lock system **S** and lower the heating element into the vat.

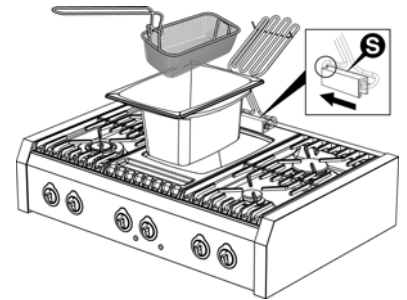

7.2 How to fry

Proceed as follows:

- pour **3 litres** of oil into the deep fryer vat. It is also possible to fry with fat: in this case, chop up approximately **3.5 kg** of frying fat.
- Switch on the heating element (see below for relative instructions).
- If using fat, leave it to melt slowly in the deep fryer vat.

To avoid abnormal overheating: until the heating element is completely covered with melted fat, we recommend switching the heating element on and off repeatedly by using the thermostat knob.

- Heat the oil or fat to a maximum of **190°C**. This temperature should not be exceeded, otherwise the oil or fat would overheat and change consistency.



The heating element **should never be switched on** unless the frying vat contains the above mentioned quantity and type of oil or fat.

The appliance is now ready for frying.

Proceed as follows:

- use the thermostat knob to set the required degree of heating: the deep fryer starts to operate and the **red and orange lights** switch on;
- wait until the **orange light** switches off, which means that the frying liquid has reached the preset temperature;
- place the food to be fried in the basket and lower it very slowly into the frying vat;

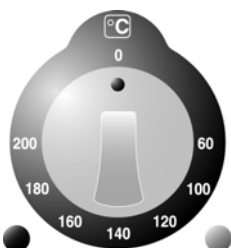



- lift the basket periodically to check the frying. When the food is crisp as required, remove the basket completely from the frying liquid and shake it lightly to remove excess liquid;
- hang the basket on the element of the deep fryer (as shown in the figure) and allow to drip.

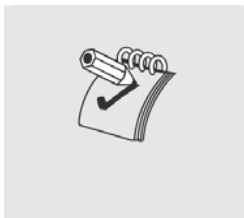
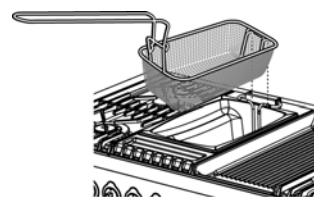

Each time the deep fryer has been used, check the level of frying liquid.

Check the level of frying liquid by lifting out the basket and checking that the level is between the two minimum and maximum marks punched on the wall of the frying vat.

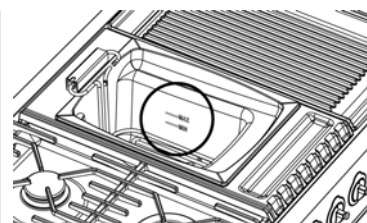

The water contained in food goes to the bottom of the frying vat, into the so-called cold area. In this way, it is practically impossible for the frying liquid to overflow out of the vat. Food particles that come out of the basket while cooking also go to the cold area.

7.2.1 Tripping of the temperature limiting device

The deep fryer is equipped with a temperature limiting device in the vat. In the event that the frying liquid temperature exceeds the preset value, this device cuts off the heating (**both lights** switch off). To reactivate the heating of the deep fryer, rearm the limiting device manually.

Proceed as follows:

- wait until the frying liquid has cooled down;
- lift the heating element upwards and remove the frying vat from the deep fryer;
- press the small **red** pushbutton on the bottom of the vat compartment, whose position is shown in the figure;
- replace the frying vat into its working position and lower the heating element.
- It is now possible to reactivate heating (**red and orange lights on**).

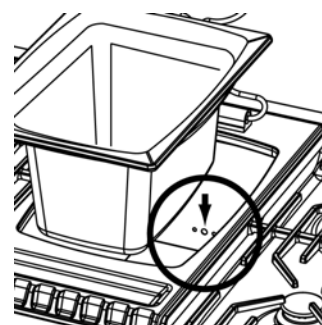

Should the appliance unexpectedly turn off after following the above instructions, switch off the master power switch and contact the Technical Service.

7.3 Indicative frying times

The frying times indicated in the table are approximate and vary according to the condition of the food and personal taste.

FOOD	FRYING TIME	HEATING
Chicken (1100 g)	20 min. (turn after 10 min.)	190°C
Fries (500 g frozen)	6 min.	190°C
Fries (500 g frozen)	repeat 2 min.	190°C
Milanese cutlet (370 g)	5 min.	170°C
Sliced onions (approx. 500 g)	5 min.	190°C

7.4 Switching off

After frying, return the thermostat knob to position "0".



8. Using the fry-top / steak grill



During normal operations, the appliance heats up considerably. Caution should therefore be used. **Do not allow children to approach the appliance.** Do not leave the fry-top/steak grill unattended while it is on.

Depending on the model, the appliance is fitted with a **fry-top** with smooth griddle, or a **steak grill** with lined griddle.

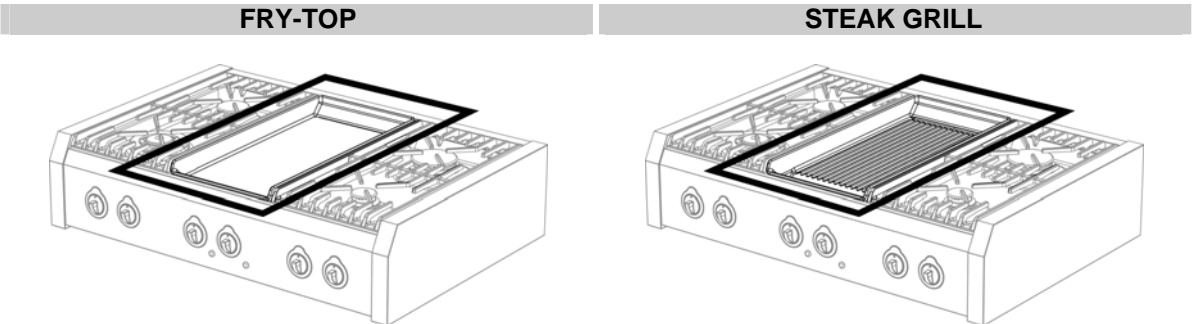

8.1 Before switching on the fry-top / steak grill

The first time it is used, the fry-top/steak grill griddle may develop an acrid or burnt smell caused by oily residue from manufacturing that may give unpleasant odours or flavours to food. To eliminate this problem, clean the griddle as described in section "13.7 Cleaning the fry-top / steak grill" before use.

8.2 Switching on

The fry-top/steak grill is equipped with **differentiated heating**. The entire surface of the griddle can be used, or only one of the two halves, front or rear.

Position the control knob of the heating element to the required setting. The **red light** switches on to indicate the appliance is working. Place the food on the griddle and cook as preferred.

8.3 Energy regulator table

The following table offers only indicative values because, according to the thickness and type of food, as well as personal taste, the heat should be higher or lower.



1 - 4	Maintaining the heat on the griddle
5 - 7	For light cooking
8 - 9	To grill
10 - 11	To grill thicker meat
11	For rapid warming and cleaning

8.4 Switching off

After cooking, return the knob to position ●.



9. Using the volcanic rock grill



During normal operations, the appliance heats up considerably. Caution should therefore be used. **Do not allow children to approach the appliance.** Do not leave the grill unattended while it is on.

9.1 Before switching on the grill

The first time it is used, the grill may develop an acrid or burnt smell caused by oily residue from manufacturing that may give unpleasant odours or flavours to food. To eliminate this problem, clean all its components beforehand as described in section “13.8 Cleaning the volcanic rock grill”.

9.2 Switching on

Proceed as follows:

- Remove the cast iron grill **very carefully** to avoid breaking it;
- lift the heating element upwards and lock it, by moving the lock system **S** towards the left as shown in the figure;
- fill the safety vat with the volcanic rock, taking care to evenly cover the whole surface, so that it does not go over the edge.

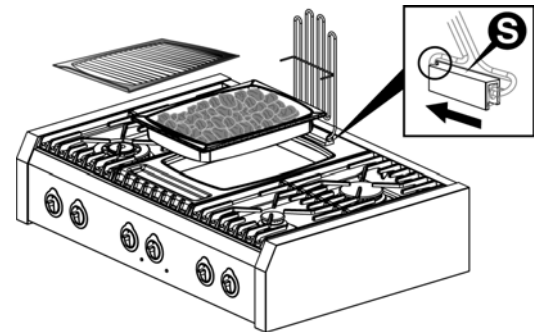

Water (up to 2 litres) can be used in the safety vat instead of volcanic rock. It is advisable to use water when cooking very fatty meat (e.g. sausage, bacon, etc.), as the meat juices will melt instantaneously in the water. This method prevents excessive smoke and simplifies the cleaning operations described in section 13.8.

The heating element should **never be switched on** unless the safety vat contains the volcanic rock or water as specified above.

- Release the lock system **S** and lower the heating element;
- reposition the cast iron grill over the heating element as shown in the figure. The cast iron grill ensures adequate heat distribution.
- The appliance is ready to be switched on.

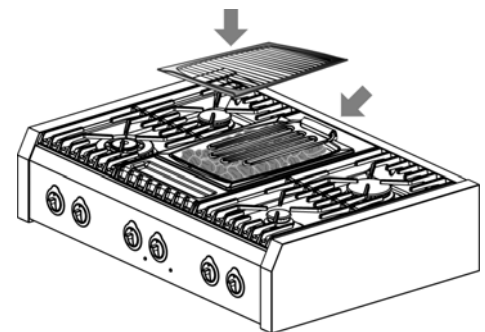

Before use, **preheat** the cast iron grill for **5 or 10 minutes** by turning the energy regulator knob to the maximum setting (11). The **red light** signals the appliance is working.

- Now turn the energy regulator knob to the required setting (see section “9.3 Energy regulator table”). Place the food on the cast iron grill and cook as required.



The appliance can also be used in the same way as an **“open burner”**, which is ideal for simmering. Only use multi-function pans whose dimensions are compatible with the cooking surface of the cast iron grill. This type of cooking is ideal for: beef stews, grilled pork, blanquette, rabbit with beer, tongue.

Proceed as follows:

- **preheat the** cast iron grill by turning the energy regulator knob to the maximum setting (11) for a few seconds;
- turn the regulator knob back to the minimum setting (1);
- position the multi-function pan containing the food to be cooked on the cast iron grill;
- put the lid on the pan to keep in humidity or remove to reduce.

9.3 Energy regulator table

The following table offers only indicative values because, according to the thickness and type of food, as well as personal taste, the heat should be higher or lower.



1 - 4	Maintaining the heat on the cast iron grill
5 - 7	For light cooking
8 - 9	To grill
10 - 11	To grill thicker meat
11	For rapid warming and cleaning

9.4 Switching off

After cooking, return the knob to position ●.



10. Using the vitroceramic hob



During normal operations, the appliance heats up considerably. Caution should therefore be used. **Do not allow children to approach the appliance.** Do not leave the vitroceramic hob unattended while it is on.

10.1 General warnings

The first time it is heated, the vitroceramic hob may develop an acrid or burnt smell caused by oily residue from manufacturing, which disappears completely after repeated use.

The vitroceramic hob is fitted with a cooking area with various diameters and power (see section "3.5 Power consumption of the vitroceramic hob"). Their position is clearly indicated with circles and the heat is delimited within the diameters marked on the glass.

10.2 Switching on



Position the pan or pot with the food to be cooked inside it on the required heating element. Turn the energy regulator knob to the required setting. After a few moments, the **latent heat light** corresponding to the selected heating element switches on.

If the vitroceramic hob is used to boil water, once it has boiled, turn the energy regulator knob to a lower setting to prevent the liquid in the pot from boiling over and soiling the surface.



Some knobs are fitted with a **supplementary heating** setting (**griddle with dual heating element**). To activate it, turn the energy regulator knob to position 11.

10.3 Switching off

After cooking, return the knob to position 11.

The vitroceramic hob features a **latent heat light** which reproduces in reduced scale the position of the heating diameters. This light signals that the surface area is still hot.

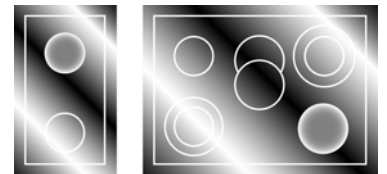

Do not clean or touch the surface until the latent heat light has switched off.



11. Using the ovens

11.1 General warnings



When the oven or grill is operating, the outer walls and oven door can become very hot. **Keep children away from the appliance. Do not allow children to sit on the oven door or play with it. Do not use the door as a stool.**

Do not cook food on the bottom of the oven.

When using the oven for the first time, or after a power cut, the display flashes regularly indicating **0:00**. To set the display, refer to section "SETTING THE TIME" on page 21.

Do not attempt to disassemble the oven door without consulting the relative instructions carefully (refer to section "14.1 Removing the oven door"): **the hinges on the oven door may injure the hands.**



HEATING BLOCK OF THE OVEN

If during normal operation the oven interrupts heating and the programmer display begins to flash and goes to zero, check whether:

- there has been a current interruption.

If the block occurs again after the cooking programme has been restarted, this means that the safety device has been tripped. This device intervenes in the event of a thermostat fault and prevents oven overheating. In such case, we recommend that you not try to light the oven again and that you contact your nearest service centre.

11.2 Drawer and storage compartment

In some models a storage drawer is provided on the lower part of the cooker beneath the oven or in the next side compartment. Use this cabinets only to store metal cooker accessories.

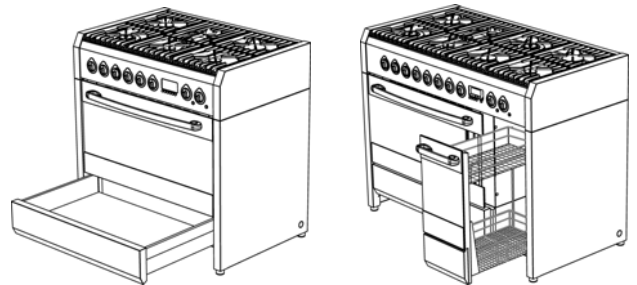

Do not store inflammable material such as cloths, paper or similar in the drawer and storage compartment.

11.3 Using the electric multifunction oven



The end of cooking display and the control knobs on the main oven **have no bearing** on the operation of the auxiliary oven.



11.3.1 Switching on the oven for the first time

The first time it is used, the oven may smoke or give off an acrid smell caused by oily residue from manufacturing that may give unpleasant odours or flavours to food. **Before putting food in the oven, heat to the maximum temperature for 30-40 minutes with the door closed and wait until the smoke or odour has stopped.**

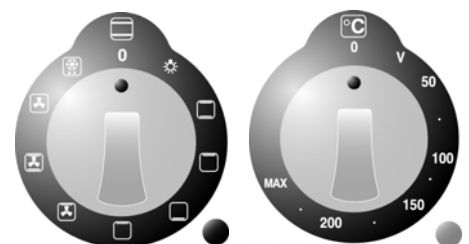





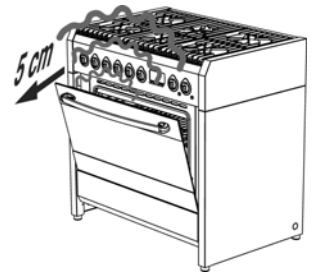

To prevent any steam in the oven from scalding, proceed as follows: turn the function switch knob to "0", or to function ; open the door in two stages: hold it partly open (**approx. 5 cm**) for 4-5 seconds, then open it completely.

Should you need to adjust the food, leave the door open for as short a time as possible to prevent the temperature inside the oven from lowering to such an extent as to jeopardise cooking.



11.3.2 Traditional cooking

Turn the function switch knob to position  and the thermostat knob in correspondence with the required temperature value. For differentiated heating over or below the food, set the function selector switch to position  (hot above) or  (hot below). For more uniform heating throughout the oven, turn the function switch knob to position .



After preheating and putting the food in the oven an air flow between the upper side of the door and the lower side of the hob may be noticed. **In case that does not happen, switch off the appliance and contact the Technical Service immediately.**

11.3.3 Convection cooking

Turn the function switch knob to position ; turn the thermostat knob in correspondence with the required temperature value.

11.3.4 Cooking with the ventilated grill

Turn the function switch knob to position ; turn the thermostat knob in correspondence with the maximum temperature value (**MAX**).

11.3.5 Cooking with the grill + roasting spit

Turn the function switch knob to position ; turn the thermostat knob in correspondence with the maximum temperature value (**MAX**). The grill and spit operate at the same time, allowing for cooking on the spit.

11.3.6 Cooking with the roasting spit

If your oven model has a roasting spit, proceed as follows:

- Slide the meat to be cooked on the spit rod **A** and secure it with the adjustable forks.
- Hang the hook **B** at the top of the oven as shown in the figure.
- Place the spit rod **A** into the hole **C** in the oven casing; before closing the oven door, make sure that the rod **A** is correctly inserted into the hole **C** (insert the rod and turn it slightly back and forth).
- Hang the other end of the spit rod to the hook **B** (the pulley of the rod **A** is situated on the handle of the hook **B**).
- Close the oven door and activate the spit by turning the function selector knob to the  position.
- When cooking is completed, open the oven door and remove the spit rod using the plastic handle **D**, which is screwed into the base of the rod **A**.

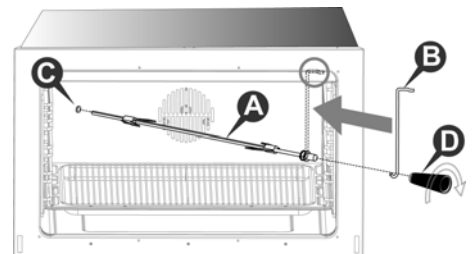

11.3.7 Defrosting

Turn the function switch knob to position , turn the thermostat knob to position "0": in this way the motor fan is activated, which moves the air inside the oven and encourages frozen food to defrost.

11.3.8 Switching off the oven

The oven is switched off by returning the thermostat knob to position "0".



11.4 Using the auxiliary oven with natural convection



The end of cooking display and the control knobs on the main oven **have no bearing** on the operation of the auxiliary oven.



The auxiliary oven with natural convection is equipped with:

- a heating element positioned on the base of the oven (at the bottom);
- a heating element positioned on the ceiling of the oven (at the top) + grill.



11.4.1 Switching on the auxiliary oven for the first time

The first time it is used, the auxiliary oven may smoke or give off an acrid smell caused by oily residue from manufacturing that may give unpleasant odours or flavours to food. **Before putting food in the oven, heat the auxiliary oven to the maximum temperature for 30-40 minutes with the door closed and wait until the smoke or odour has stopped.**

To start heating the auxiliary oven, select the temperature (from **60** to **MAX**) or the required function by turning the thermostat knob.

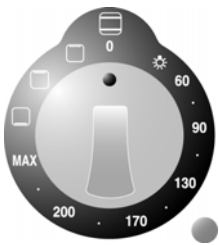

11.4.2 Cooking with the grill (auxiliary oven)

Turn the thermostat knob to position  and let the auxiliary oven preheat for approximately 5 minutes. For correct operations, position the grill shelf on the third guide from the bottom. It is however possible to vary the position of the grill shelf according to personal taste and different cooking requirements. Before putting food in the oven, allow it to preheat for 5 minutes. A cooling system prevents the control knobs from overheating.

11.4.3 Cooking with the spit (auxiliary oven)

Turn the thermostat knob to position  and let the auxiliary oven preheat for approximately 5 minutes. In the meantime, proceed as follows:

- insert the food on to the spit rod **A** taking care to hold it firm with the two forks **B**, and balancing it so as to avoid straining the gearmotor;
- place the pulley **C** of the spit rod onto the support **D** after introducing the opposite end into the hole **E**, until the coupling with the gearmotor **F** so that the rod rotates;
- pour a little water into the dripping pan and position it under the spit rod;
- monitor the cooking from time to time and check the spit rod is rotating correctly;
- at the end of the cooking, switch off the auxiliary oven by returning the thermostat knob to position "0";
- remove the spit rod from the auxiliary oven using the knob **G** and wearing an oven glove.

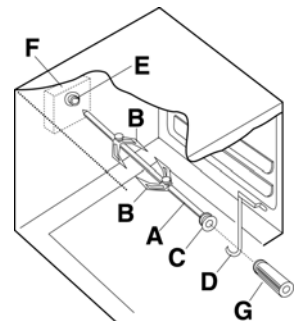

11.4.4 Switching off the auxiliary oven

The oven is switched off by returning the thermostat knob to position "0".



11.5 Using the convection electric oven



The end of cooking display and the control knob on the convection oven **have no bearing** on the operation of the grill oven.



The convection oven is equipped with a circular heating element with a fan located on the rear wall of the oven.

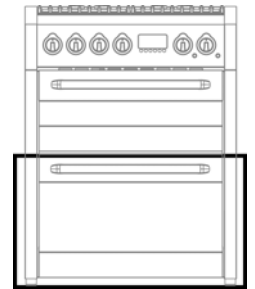

11.5.1 Switching on the oven for the first time

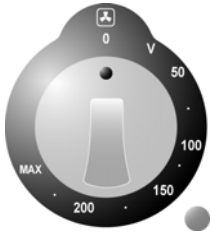

The first time it is used, the oven may smoke or give off an acrid smell caused by oily residue from manufacturing that may give unpleasant odours or flavours to food. **Before putting food in the oven, heat to the maximum temperature for 30-40 minutes with the door closed and wait until the smoke or odour has stopped.**



To prevent any steam in the oven from scalding, proceed as follows: turn the knob to "0", or to function "V"; open the door in two stages: hold it partly open (**approx. 5 cm**) for 4-5 seconds, then open it completely. Should you need to adjust the food, leave the door open for as short a time as possible to prevent the temperature inside the oven from lowering to such an extent as to jeopardise cooking.

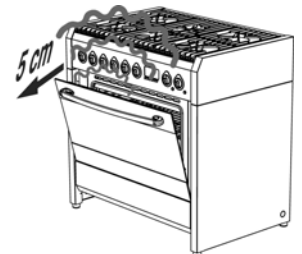

11.5.2 Cooking with convection oven

Turn the knob in correspondence with the required temperature value. It is possible to vary the position of the grill shelf according to personal taste and different cooking requirements.

11.5.3 Switching off the oven

The oven is switched off by returning the knob to position "0".



11.6 Using the grill oven with natural convection



The grill oven knob do **not influence** the functioning of the convection oven.



The grill oven with natural convection is equipped with:

- a heating element positioned on the base of the oven (at the bottom);
- a heating element positioned on the ceiling of the oven (at the top) + grill.

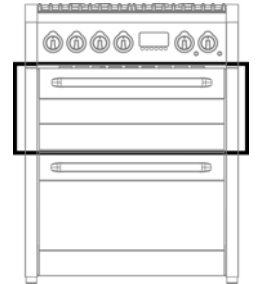

11.6.1 Switching on the grill oven for the first time

The first time it is used, the grill oven may smoke or give off an acrid smell caused by oily residue from manufacturing that may give unpleasant odours or flavours to food. **Before putting food in the oven, heat the grill oven to the maximum temperature for 30-40 minutes with the door closed and wait until the smoke or odour has stopped.**

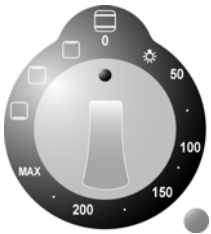

It is possible to switch on the heating of the grill oven by turning the knob to the required temperature (from **50°C** to **MAX**) or function.



11.6.2 Cooking with the grill

Turn the knob to position  and let the grill oven preheat for approximately 5 minutes. For correct operations, position the grill shelf on the second guide from the bottom. It is possible to vary the position of the grill shelf according to personal taste and different cooking requirements. A cooling system prevents the control knob from overheating.

11.6.3 Traditional cooking

For differentiated heating over or below the food, set the function selector switch to position  (hot above) or  (hot below).

11.6.4 Switching off the grill oven

The oven is switched off by returning the knob to position "0".



12. Cooking suggestions

12.1 Suggestions for using the hob burners correctly

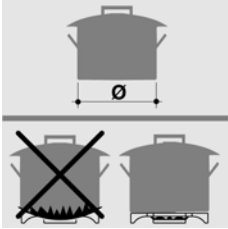

The diameter of the base of cooking recipients should fit the diameter of the burner used (see adjacent table). The burner flame must never be wider than the diameter of the recipient. Use recipients with a flat base. Where possible use pots with a lid, as this allows less power to be used. To reduce cooking times for vegetables, potatoes, etc., use little water.

Burner	Recipient diameter (in cm)
Rapid	from 24 to 26
Semi rapid	from 16 to 22
Auxiliary	from 8 to 14
Triple-ring	from 24 to 26
Fish kettle	from 16 to 35

12.2 Suggestions for using the deep fryer correctly

Do not add salt or spices to food while the basket is still positioned above the frying vat, as the oil or fat would be altered, jeopardising the flavour of subsequent fries.

For large quantities of food, we recommend removing the basket from the frying vat every **1-2 minutes**, so that the frying liquid can return to the preset temperature more quickly. The food to be fried must always be covered by the frying liquid. Should this not be possible (with chicken for instance), turn it half way through cooking.

At the end of the cooking, remove any food residue from the frying liquid. If, despite the correct temperature setting, the food is not crisp and the frying liquid is dark, it should be replaced by carefully following the instructions given in section "13.6.1 Discharging the frying liquid".



In order to avoid the dangerous combustion of the frying liquid, do not activate the open burners near the deep fryer.

12.3 Suggestions for using the fry-top / steak grill correctly

The **fry-top** griddle is smooth, whereas the **steak grill** is lined and can be used to obtain the typical rhomboidal pattern together with the delicious flavour of barbecue cooking.

Foods cooked on the fry-top/steak grill have a special taste that does not require the excessive use of spices. It is possible to cook in different ways. For example, different foods, such as meat and fish, can be cooked at the same time. Before cooking meat, we recommend treating it with flavoured oil or marinating it for a few hours.

A little tip: meat should always be salted after cooking on the griddle, so that its juices do not come out prematurely.

12.4 Suggestions for using the volcanic rock grill correctly

Cooking food on the cast iron grill creates a considerable quantity of smoke. Sometimes, while cooking very fatty meat, small flames may appear similar to those seen during barbecue cooking (see section 9.2 for how to solve this problem). Before placing fish on the grill, we recommend greasing it slightly with oil or melted butter. This will stop the fish sticking to the surface of the grill.



The appliance can also be used in the same way as an "open burner", which is ideal for simmering. Only use multi-function pans whose dimensions are compatible with the cooking surface of the cast iron grill. This type of cooking is ideal for: beef stews, grilled pork, blanquette, rabbit with beer, tongue (see instructions in section 9.2).



12.5 Suggestions for using the vitroceramic hob correctly

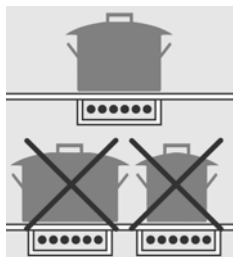

In order to obtain good efficiency and adequate energy consumption, it is essential to use only recipients that are suitable for electric cooking. The diameter of the base of the recipient must be the same as the diameter of the outline of the cooking area. Energy is wasted if they do not correspond.

The base of the recipient must be very thick and perfectly flat. It should also be clean and dry, as should the glass on the hob.

Do not use cast iron pots or pots with a rough base, as they may scratch the surface.

When using the vitroceramic hob, it must be thoroughly cleaned before switching on the heating elements.

The glass may be scratched if pans are placed on abrasive residues. Any scratches do not however jeopardise the cooking procedure.

The ideal thickness for the base of the pans is:

- **2-3 mm** in enamelled steel;
- **4-6 mm** in stainless steel with double base.

Before cooking food with a high sugar content (e.g. jam), apply a protective product to the cooking surface to prevent it from being damaged if the food spits or boils over.

12.6 Suggestions for using the oven correctly



The oven allows to optimise cooking. It is possible to cook traditionally, with convection and with the grill.

The oven door should be completely closed for all types of cooking.

12.6.1 Traditional cooking

With this type of cooking, the heat comes from the top and the bottom. It is therefore preferable to use the central guides. If the cooking requires a hotter temperature from the bottom or from the top, use the lower or upper guides. Traditional cooking is recommended for all food that requires high cooking temperatures, or long braising times. This system is also recommended when cooking with recipients made of terracotta, porcelain and similar materials.

12.6.2 Convection cooking

With this type of cooking, the food is heated by preheated air that is circulated in the oven thanks to a fan located on the rear wall of the oven. Heat rapidly and evenly reaches all parts of the oven, thus enabling different food to be cooked at the same time on different shelves. Humidity is eliminated from the air and the drier area prevents odours and flavours from being spread and mixed.

The possibility of cooking on more than one shelf allows you to cook many different dishes at the same time. Biscuits and mini pizzas can be cooked in three different baking tins. The oven, however, can also be used for cooking on a single shelf. The lower shelves can be used so that it is easier to monitor cooking.

Convection cooking is particularly convenient for bringing frozen food rapidly back to room temperature, for sterilising preserves or home-made fruit in syrup and, finally, for drying mushrooms or fruit.



12.6.3 Cooking with the grill

The heat comes from the top. Almost all meat can be grilled, with the exception of lean game and dishes such as meat-loaf. Meat and fish to be grilled should be lightly drizzled with oil and placed on the grid bars, which should be placed in the guides closest to or farthest away from the grill element, depending on the thickness of the meat, so as to avoid burning the surface and cooking too little inside.

Suitable for: relatively thin meat; toasted sandwiches.



Pour 1 or 2 glasses of water into the dripping pan to avoid smoke forming due to drops of juice or fat. While cooking with the grill, the dripping pan should always be positioned in the 1st guide from the bottom.

12.6.4 Cooking with the ventilated grill

Using the combination of grill and fan .

This type of cooking allows the heat to penetrate gradually inside the food, even though the surface is directly exposed to the grill.

Suitable for: thicker meat; game-birds.

12.6.5 Cooking meat and fish

Meat to be cooked in the oven should weigh at least **1 kg**. Very tender red meat to be cooked rare (roast beef, fillet, etc.), or which should be well cooked on the outside and preserve all its juices on the inside, require cooking on high temperatures for a short time (**200-250°C**). White meat, game-birds and fish require cooking on low temperatures (**150-175°C**).

The ingredients for the sauce should only be placed in the baking tin if the cooking time is short, otherwise, they should be added in the last half hour. Meat can be placed on an ovenproof plate or directly on the grid bars, below which the dripping pan should be placed to collect the juice. Press the meat with a spoon to check if it is done. If it is firm, it is cooked.

At the end of the cooking, wait at least **15 minutes** before cutting the meat so as not to lose the juices. Before serving, plates can be warmed in the oven at minimum temperature.

12.6.6 Baking

Beaten mixtures must stick to the spoon because excess fluidity would prolong the cooking time. Sweets require moderate temperatures (generally between **150-200°C**) and require preheating (**approximately 10 minutes**). The oven door must not be opened until at least $\frac{3}{4}$ of the way through the cooking time.



12.6.7 Recommended cooking tables

Cooking times vary according to the nature, homogeneity and volume of the food. We recommend monitoring your first attempts and checking the results, as similar results are obtained by cooking the same dishes in the same conditions. The following three tables (I, II and III) provide guidelines.

TABLE OF CONVECTION AND TRADITIONAL COOKING TIMES (I)

TYPE OF COOKING	QUANTITY KG.	POSITION OF GUIDE FROM BOTTOM		TEMPERATURE °C		TIME IN MINUTES
		CONVECTION 	TRADITIONAL 	CONVECTION 	TRADITIONAL 	
BAKING						
WITH BEATEN MIXTURE, IN A TIN	1	1-3	2	175	200	60
WITH BEATEN MIXTURE, ON THE DRIPPING PAN	1	1-3	2	175	200	50
SHORT PASTRY, PIE BASE	0.5	1-3	3	175	200	30
SHORT PASTRY WITH MOIST FILLING	1.5	1-3	2	175	200	70
SHORT PASTRY WITH DRY FILLING	1	1-3	2	175	200	45
MIXTURE WITH NATURAL LEAVENING	1	1-3	1	175	200	50
SMALL CAKES	0.5	1-3	3	160	175	30
MEAT						
VEAL	1	2	2	180	200	60
BEEF	1	2	2	180	200	70
ENGLISH STYLE ROAST BEEF	1	2	2	220	220	50
PORK	1	2	2	180	200	70
CHICKEN	1-1.5	2	2	200	200	70
STEWES						
BEEF STEW	1	1	2	175	200	120
VEAL STEW	1	1	2	175	200	110
FISH						
FILLET, STEAK, COD, HAKE, SOLE	1	1-3	2	180	180	30
MACKEREL, TURBOT, SALMON	1	1-3	2	180	180	45
OYSTERS	1	1-3	2	180	180	20
TIMBALE						
PASTA TIMBALE	2	1-3	2	185	200	60
VEGETABLE TIMBALE	2	1-3	2	185	200	50
SWEET AND SAVOURY SOUFFLÉS	0.75	1-3	2	180	200	50
PIZZA AND CALZONE	0.5	1-3	2	200	220	30

- The times refer to cooking on one shelf only; for more than one shelf increase the time by **5-10'**.
- The cooking times do not include preheating which takes **approximately 15'**.
- When cooking on more than one shelf, the guides are given in the preferential position.
- For beef, veal, pork and turkey roasts, either with bone or rolled, increase the time by **20'**.

TABLE OF COOKING TIMES WITH GRILL AND VENTILATED GRILL (II)

TRADITIONAL GRILLING				
TYPE OF COOKING	QUANTITY KG.	POSITION OF GUIDE FROM BOTTOM	TEMPERATURE °C	TIME IN MINUTES
CHICKEN	1-1.5	3	MAX	30 PER SIDE
TOASTED SANDWICHES	0.5	4	MAX	5 PER SIDE
SAUSAGES	0.5	4	MAX	10 PER SIDE
PORK CHOPS	0.5	4	MAX	8 PER SIDE
FISH	0.5	4	MAX	8 PER SIDE
GRILLING WITH VENTILATED GRILL				
TYPE OF COOKING	QUANTITY KG.	POSITION OF GUIDE FROM BOTTOM	TEMPERATURE °C	TIME IN MINUTES
ROAST PORK	1.5	2	170	180
ROAST BEEF	1.5	3	220	60
CHICKEN	1.2	2	190	90

- The dripping pan for collecting cooking juices should always be positioned in the **1st guide from the bottom**.

TABLE OF DEFROSTING TIMES (III)

DEFROSTING			
TYPE OF FOOD	QUANTITY KG.	POSITION OF GUIDE FROM BOTTOM	TIME IN MINUTES
READY-TO-EAT DISHES	1	2	45
MEAT	0.5	2	50
MEAT	0.75	2	70
MEAT	1	2	110

- Defrosting at room temperature has the advantage of not modifying the flavour and appearance of food.



13. Cleaning and maintenance



Before cleaning or carrying out maintenance, switch off the power supply to the appliance and close the gas tap.



Warning: Servicing should be carried out only by authorised personnel. Do not clean the surfaces of the appliance when they are still hot. Do not use pressure or steam spray guns to clean the appliance.

13.1 Cleaning stainless steel surfaces



To clean and preserve the stainless steel surfaces and remove the toughest stains, always use specific products, provided **they do not contain chlorine-based abrasives or acid substances**, or a little warm vinegar.

Pour the product onto a damp cloth and wipe the steel surface. Rinse carefully and dry with a soft cloth or a piece of deerskin.

Do not under any circumstances use metallic sponges or sharp scrapers that may damage the surfaces. Only use non-scratch, non-abrasive sponges and, if necessary, wooden or plastic utensils.

13.2 Cleaning enamelled surfaces

Clean with a non-scratch, **non-abrasive** sponge dampened with soap and water. Grease stains can easily be eliminated with hot water or a product specifically made for cleaning enamel. Rinse carefully and dry with a soft cloth or a piece of deerskin.

Do not use products containing abrasives, scouring pads, steel wool or acid, which may spoil the surfaces. Do not leave acid or alkaline substances on the enamel (lemon juice, vinegar, salt, etc.).

13.3 Cleaning the knobs and the control panel

Clean the knobs and the control panel with a damp cloth.

13.4 Cleaning the grids and burners

To clean the grids and hob burners, remove them from their housing by lifting them upwards as shown in the figure, and immerse them in a solution of warm water and **non-abrasive** detergent for about ten minutes. Rinse and dry carefully.

Always check that none of the burner openings is clogged.

Be sure to refit the burner correctly, checking the flame is uniform.

We recommend carrying out this operation at least once a week and each time it is necessary.

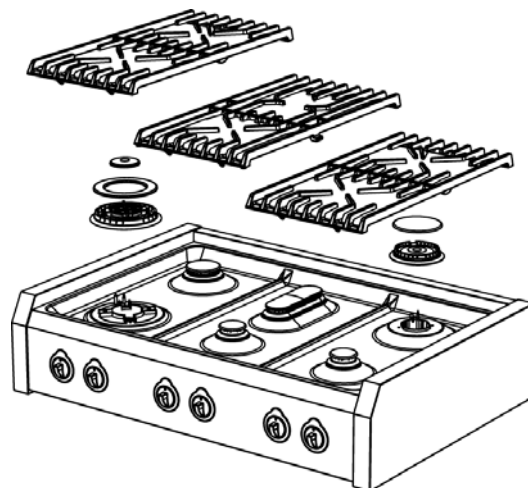



13.5 Cleaning the igniter plugs and thermocouples

In order for the igniter plugs and thermocouples to operate correctly, they must be kept clean at all times. Check them frequently and, if necessary, clean them with a damp cloth. Any dry residue should be removed with a toothpick or needle, **taking care not to damage the insulating ceramic part.**

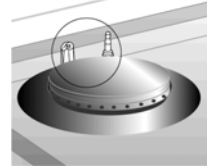

13.6 Cleaning the deep fryer

13.6.1 Discharging the frying liquid

Allow the frying liquid to cool completely before carrying out this operation.

Proceed as follows:

- lift the heating element upwards, leave it to drip on the vat and dry it with kitchen roll;
- lock the heating element by moving the lock system **S** towards the left as shown in the figure;
- remove the frying vat;
- pour the frying liquid into an appropriate container and dispose of it according to current standards for the disposal of exhausted oil.
- The deep fryer's stainless steel vat should be cleaned with a specific product that **does not contain chlorine-based abrasives or acid substances**, or a little warm vinegar;
- rinse and dry the vat and basket thoroughly;
- clean the deep fryer heating element with a non-scratch, **non-abrasive** sponge and detergent and then rinse thoroughly;
- replace the deep fryer into its working position. Finally, release the lock system **S** and lower the heating element into the vat.

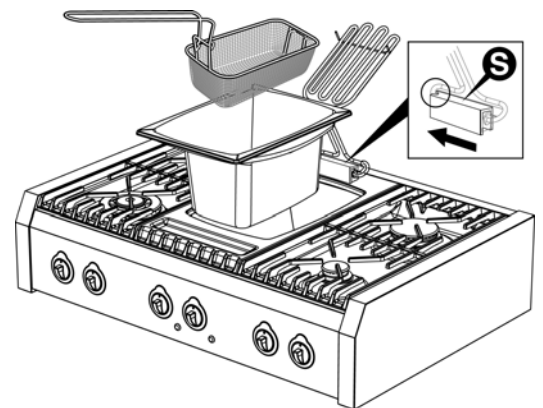

13.7 Cleaning the fry-top / steak grill

Any grease deposits on the fry-top/steak grill can be eliminated more easily when the griddle is still warm. If necessary, leave it to cool and soak for a few minutes. Finally, clean with warm salted water, dry with a tea cloth or kitchen roll.

After each use, the vitroceramic surface **V** underneath the fry-top/steak grill should also be cleaned. Any residue of meat or grease can be removed by proceeding as follows:

- remove the fry-top/steak grill from its housing;
- turn the knob to position **11**;
- after approximately **20-30 minutes**, even the toughest residue can easily be cleaned off the vitroceramic surface with a wooden spatula;
- switch off the heating and leave to cool, then clean the vitroceramic surface **V** with specific products;
- dry thoroughly and return the fry-top/steak grill to its working position.

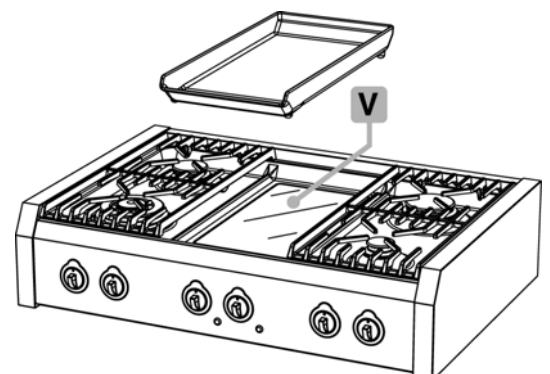



13.8 Cleaning the volcanic rock grill



After cooking, the cast iron grill and other components will remain hot for a certain length of time. Make sure they are completely cool before handling them for cleaning.

Proceed as follows:

- clean the cast iron grill by immersing it in hot water and washing up liquid. Do not under any circumstances use **abrasive or corrosive** detergents (**e.g. powder products or metallic sponges**). Rinse and dry carefully.



*While cleaning the grill, **handle it with care** as it is fragile due to the material it is made of and its thickness.*



*Any grease deposits can be removed more easily by heating the grill for **5 or 10 minutes** (knob in position **11**). Allow the grill to cool, remove it, rinse and dry well with a clean cloth.*

- Lift the heating element upwards and clean it with a damp sponge;
- lock the heating element by moving the lock system **S** towards the left as shown in the figure.
- Remove the safety vat. Place the volcanic rock in a suitable container or pour away the water with the cooking fat residue.

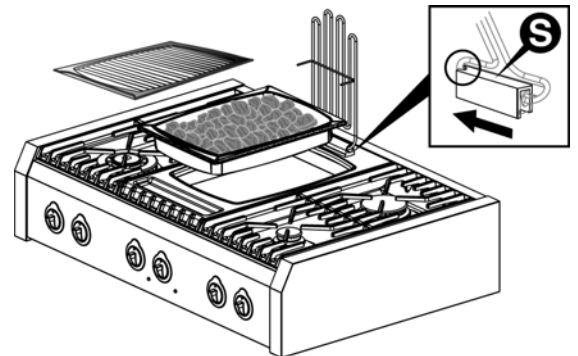

*The volcanic rock contained in the collection basin is not subject to wear and therefore never has to be replaced. To eliminate any unpleasant odours due to normal use, stir up the stones and heat them for a few minutes. If cooking grease is deposited on the surface of the stones, it is sufficient to heat them in an oven for high temperature pyrolysis. The same quality of cleaning can be obtained by turning the energy regulator knob of the grill to the maximum position (**11**) for **5 or 10 minutes**, depending on the amount of soil that has accumulated. In any case, volcanic rock replacements can be found in any store that sells household goods.*

- The stainless steel safety vat should be cleaned with a specific product that **does not contain chlorine-based abrasives or acid substances**, or a little warm vinegar (it is dishwasher safe). Rinse and dry carefully;
- replace the safety vat into its working position. Finally, release the lock system **S** and lower the heating element over the vat.

13.9 Cleaning the vitroceramic hob

The vitroceramic hob must be cleaned regularly, each time it is used if possible, when the latent heat lights are off.

Any light-coloured marks caused by aluminium-based pans can be removed with a damp cloth dipped in vinegar.

Any burnt residue left after cooking can be removed with a wooden spatula. Rinse with water and dry well with a clean cloth.

Do not under any circumstances use **abrasive or corrosive** detergents (**e.g. powder products, oven sprays, stain-removers or metallic sponges**).



Any grease deposits on the vitroceramic hob can be removed more easily by heating it for approximately **20-30 minutes** (knob in position **11**). Afterwards, this residue can be cleaned off with a wooden spatula. Allow the surface to cool, rinse with water and dry well with a clean cloth.

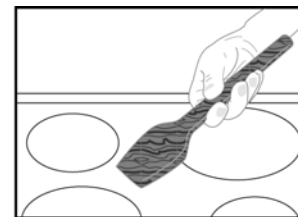
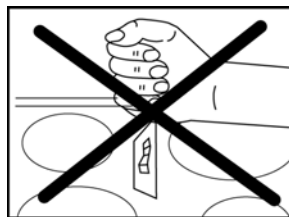

In the event that aluminium or plastic marks, sugar or food containing sugar melt on the cooking surface, **remove immediately** while the surface is still warm with a wooden spatula. This will prevent any damage to the surface.



*The cooking surface of the vitroceramic hob is extremely resistant. It is not however unbreakable and may be damaged, above all by pointed or hard objects if dropped onto it with a certain force. **Warning! If any crack should appear on the hob, isolate the cooker from the main supply and do not use the appliance to avoid electrocution. Call Customer Services immediately.***

13.10 Cleaning the oven

In order to preserve the oven well, it should be cleaned regularly, each time it is used if possible, **after leaving it to cool**: in this way it is possible to remove any residue more easily, preventing it from burning the next time the oven is used.

Clean the stainless steel parts and enamelled parts as described in the corresponding sections "13.1 Cleaning stainless steel surfaces" and "13.2 Cleaning enamelled surfaces".

Take out all the removable parts and wash them separately. Rinse and dry thoroughly with a clean cloth.

13.10.1 Cleaning the oven walls

Never use detergent products to clean this type of oven.

The walls of the oven can be cleaned using white vinegar and wiped with a cloth dampened with water. Subsequently, heat the oven for at least one hour at **150°C** to facilitate cleaning. When the oven has cooled, wipe it again with a damp cloth.

13.10.2 Cleaning the oven door

We recommend always keeping the oven door clean. Use kitchen roll and on tougher dirt use a damp cloth and household detergent.



Spray products for cleaning the oven must not be used to clean the fan and the thermostat sensor inside the oven compartment.

13.11 Replacing the oven light bulb



Before carrying out maintenance, switch off the power supply to the appliance.

Proceed as follows:

- open the oven door;
- unscrew the glass safety cap anticlockwise; unscrew the bulb and replace it with another one for **high temperatures (300°C)** with the following characteristics:

Voltage: 240 Vac / 50 Hz
Power: 15 W
Attachment: E 14

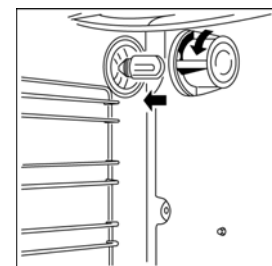

- Refit the glass cap and switch on the power. It is possible to check that the oven light is working even when the door is closed by turning the function switch knob to position .



14. Special maintenance

Periodically, it is necessary to maintain or replace some parts that are subject to wear and tear. Specific instructions are given below for each type of maintenance.



Before carrying out maintenance, switch off the power supply to the appliance and close the gas tap.

14.1 Removing the oven door

The oven door can be completely removed to enable more thorough cleaning. Though this operation is possible, it should not be performed by everyone, as it requires the strength to hold up the door and a minimum of expertise to re-fit it. If you are not sure of being able to do this, we recommend that you clean the door without taking it off or, in special cases, that you contact the nearest authorised service centre.

To remove the door, proceed as follows:

- Open the oven door and release the safety catches of the hinges by turning the respective pins **A** (one for each hinge) backward.
- Partially close the door until there is no more load tension on the springs (the door will form an angle of about 30°).
- Using both hands, accompany the movement of the door towards closure and simultaneously lift it upward.
- Turn the lower part of the door towards the outside to free the hinges **B** from their seats.

If you need to remove any dry residues or dust deposited on the inner part of the windows, turn the door upside down as shown in the figure, slide a soft bottle brush into the spaces between the glass plates and brush gently.

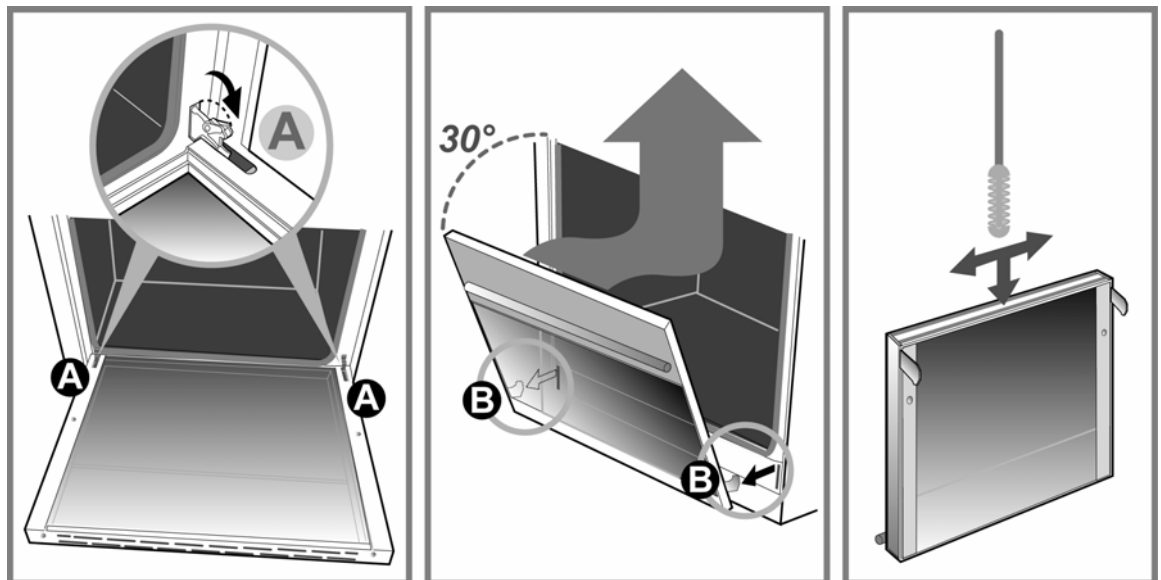

To re-fit the door, carry out the instructions given above in the inverse direction. When the hinges **B** are back in their seats, open the door all the way and re-fit the safety catches of the hinges, lowering the respective pins **A** (one for each hinge).

CAUTION: After re-fitting the door, **always** be sure to re-fit the hinge safety catches.

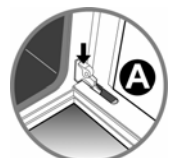



14.2 Removing the side rack-holder frames

The rack-holder frames can be removed to clean them separately and to facilitate cleaning the oven walls. The frames are hooked to the oven wall in the three points indicated by the arrows in the figure (detail 1).

- Press downward with your fingers as shown in detail 2 of the figure to release the frame from the upper pin.
- Lift the frame upward and take it out.

To re-fit proceed in the inverse direction. Set the lower part of the frame on the respective pins and press the upper part against the oven wall until it hooks onto the pin.

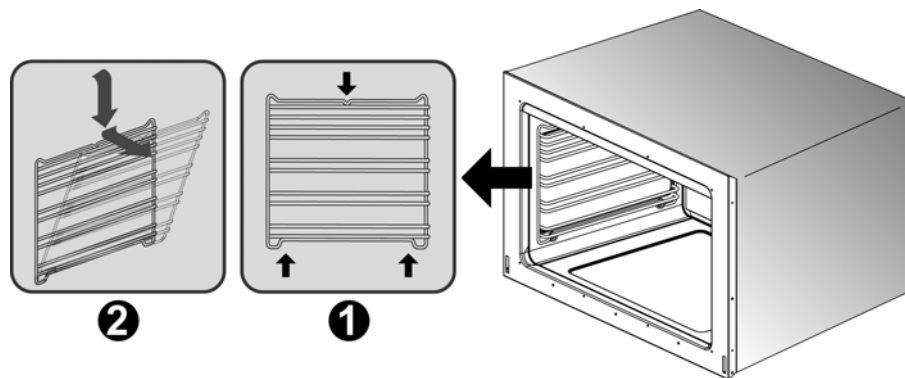

14.3 Removing and cleaning the inside oven fan

The inside fan of the ventilated oven may require periodic cleaning. To disassemble the fan proceed as follows:

- **Make sure that the power supply to the appliance is switched off.**
- Remove all inside components (dripping pan, shelves).
- Loosen and remove the four screws **A** from the cover panel.
- Remove the cover panel **B**.
- Use a coin to loosen the fixing nut **C** of the fan (this threading is inverse; to loosen turn clockwise).
- Remove the fan **D** and wash it by immersing it in warm water and dish detergent. **Never use abrasive or corrosive detergents, powdered products, or metal scrubbers.** Rinse the fan and dry it thoroughly.

Re-fit the fan and the cover by working in the inverse direction to the instructions for removal.

