

Cooking collection

Instructions for Use and Warranty Details

TO600X Designer Multifunction Electronic Touch Control Oven - Stainless Steel
TO600W Designer Multifunction Electronic Touch Control Oven - White

Congratulations on the purchase of your new appliance. This appliance has been designed and manufactured to give you years of reliable performance.

For best results, carefully read the instructions on how to install your new appliance. Correct installation will avoid delays and unnecessary service calls.

Once installation is complete, read this booklet carefully and get to know the controls and the features of your new appliance.

We reserve the right to alter the specifications with no influence on the operation of the appliance. This instruction manual cannot be reason for a claim.

Electric oven

This electric oven is manufactured for domestic use only.

For best results, carefully read the instructions on how to install your new appliance. Correct installation will avoid delays and unnecessary service calls.

Our appliances are packed in environmentally friendly materials which may be recycled, deposited or destroyed without any hazard to the environment. Such packaging materials are also labelled accordingly.

Once the life cycle of your appliance is over, ensure you do not to pollute the environment.

Deliver it to an authorised collector of used household appliances.

This instruction manual cannot be reason for a claim.

Safety warnings are listed on page 4.

The first thing to do is to check if your appliance has arrived undamaged. In case you find any transport damages, please report it immediately to your nearest Kleenmaid Store on 13 13 08.

We hope your oven will successfully serve its purpose for many years.

Contents

Safety precautions	4	Telescopic slide guides	
Intended use		Grease filter	
Cooling fan		Baking pastry	
Oven door delay switch		Roasting	
Description of the appliance	5	Grilling and browning (barbecue)	
Control panel description	5	Preserving of fruit and vegetables	
Prior first use	6	Defrosting	
Oven		Cleaning and maintenance	24
Tips for the use of the oven		Oven	
General setting options of oven control	7	Troubleshooting guide	26
Use of oven	8	Important!	
Alternatives with the oven off:		Replacement of parts	27
Selection and setting of oven temperature		Other accessories	
Alarm timer		Oven light bulb	
Safety sensor block		Instructions for installation and connection ...	27
Programmed roasting with the meat probe		Safety precautions for installation	
The oven may be controlled in two ways	12	Installation of electric oven	28
Switching between the two control modes		Electric connection	29
Food selection mode		Technical information	30
Operation mode selection	13	After sale service	30
Important warnings!		Repairs	
Modes of operation		Rating plate	
Oven guide levels			
Oven accessories			

Safety precautions

- To avoid any possible hazard, the appliance must be installed by qualified personnel only.
- Any repairs by unqualified persons may result in electric shock or short circuit. In order to avoid possible injuries to your body or to the appliance, do not attempt any repairs by yourself. Such work should be carried out by qualified service personnel.

Warning! The appliance is not intended for use by young children or infirm persons without supervision. Young children should be supervised to ensure that they do not play with the appliance

- **Danger of burns!** The oven and cooking accessories may become very hot during operation. Make sure children are kept out of reach and warn them accordingly. To avoid burns use kitchen clothes and gloves when handling hot parts or utensils.
- Mains lead of adjacent appliances may be damaged if trapped between the oven doors, and may produce short circuit. Therefore keep them at safe distance from the appliance.
- Never clean the oven with a high-pressure steam cleaning device, as it may provoke a short circuit.
- Oven door may become very hot during operation. Therefore, some models are equipped with a third glass to reduce the surface heat of the outer glass, as an extra protection against burns.

Intended use

This appliance is intended for use in your household. Never use the appliance for any other purpose!

These instructions describe in detail all the particulars and possibilities of its use.

Cooling fan

(certain models only)

The appliance is equipped with a built-in cooling fan, which cools the casing and the control panel of the appliance.

The cooling fan can be operated by selecting any of the oven operation modes.

Extended performance of cooling fan

(applies to some models only)

Cooling fan works for some time after the oven is turned OFF and thus additionally cools the appliance.

Oven door delay switch

(certain models only)

The oven door is fitted with special delay switch which turns the oven element off (only in hot air heating mode) when the oven door is opened, and restarts the heating when the oven door is closed again.

Description of the appliance

The figure shows one of the built-in models. These instructions have been prepared for models with different accessory options, so they may contain

certain functions and accessories your model might not have.

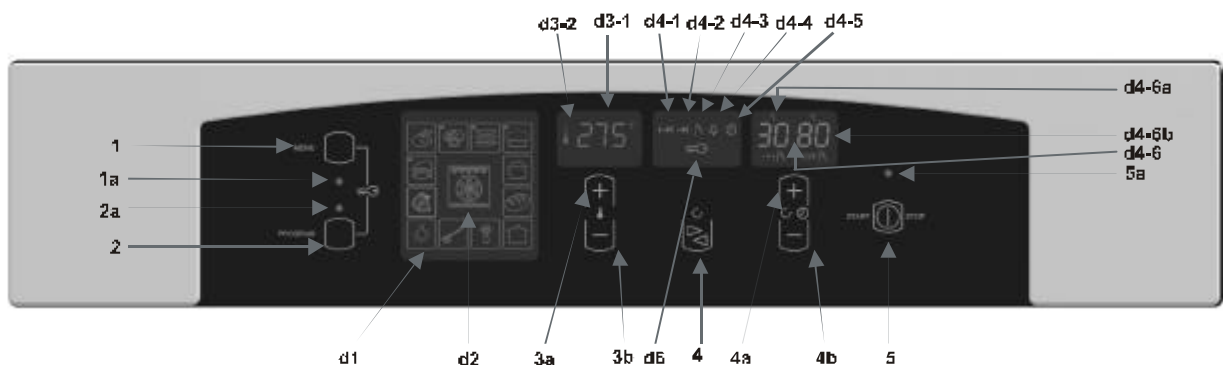

Control panel description

- | | |
|---|---|
| <p>1 Food selection sensor; food selection display (d1); signal lamp (green) (1a)</p> <p>2 Mode selection sensor; mode selection display (d2); signal lamp (red) (2a)</p> <p>3 Oven temperature selection (3a, 3b); temperature selection display (d3-1); oven thermostat signal lamp (d3-2)</p> <p>4 Selection sensor for symbols:
 – oven operation period (d4-1);
 – end of oven operation (d4-2);
 – meat probe (d4-3);</p> | <p>– alarm timer (d4-4);</p> <p>– current time (d4-5);</p> <p>– selection sensor display 4 (d4-6):
 – meat probe temperature display (d4-6a);
 – meat probe temperature setting display (end of oven operation) (d4-6b);
 – selection sensor value setting 4 (4a, 4b)</p> <p>5 ON/OFF sensor; signal lamp (red) (5a); blockage of operation display – activation by simultaneous pressing of 1 and 2 for approximately 5 seconds (d6).</p> |
|---|---|

Prior first use

Oven

Take all the accessories out of the oven and clean it with warm water and mild detergent. Never use aggressive cleaners as they may cause scratches! When you first use your oven, the oven will need to 'settle'. That is, it needs to burn off production residues and dust. The metal used will also expand slightly when first used. You may experience some crackling sounds, a strong smell and an emission of smoke.

This is perfectly normal.

We advise you to anticipate this 'settling' prior to use. To 'settle' the oven, using an empty oven select fan forced and set at a temperature of 250°. Allow the oven to 'settle' for ½ hour, and then turn to traditional mode and heat for a further ½ hour. During this procedure the room should be well ventilated.

Tips for the use of the oven

- If possible use dark, silicone coated or enamel baking pans, because of their excellent thermal conductivity.
- Preheating of the oven is necessary only if recommended by the recipe or if recommended in the Baking Tables.

Heating of an empty oven consumes a lot of energy. Save it by baking several pizzas or cakes consecutively, one after the other, while the oven is still warm. Towards the end of baking, the oven may be switched off about 10 minutes before completion, thereby making use of the remaining residual heat.

General setting options of oven control

- **Sound signal volume**
 - When no other function is active it is possible to set the sound signal volume by touching the sensor **(4b)**. The display **(d4-6)** indicates symbols of 4 volume levels.
- **Sound signal duration:**
 - oven operation period sound signal **(d4-1)**, end of oven operation **(d4-2)** and meat probe **(d4-3)** last 7 minutes;
 - alarm timer sound signal **(d4-4)** lasts 3 minutes
 - After the expiry of the indicated time the sound signal goes off automatically.
- **Each touch of the sensor is accompanied by a beep.**
- **Increasing the speed of the display setting.**

Pressing the sensor for a period of 5 seconds continuously can increase the speed of the displayed setting.
- **Simultaneous pressing of (-) and (+) sensors (3a/3b) ali (4a/4b)**

Resets the settings to "0", except for the temperature setting display **(d3-1)** which is changed to 30°C, and the end of operation sensor **(d4-2)** which changes to indicate the time of day.

In case the ON/OFF sensor **(5)** is not pressed within 5 seconds, all settings are reset automatically, except for the time of day and the alarm timer.

 In case of power failure less than 1 minute long, all settings remain unchanged and the oven resumes normal operation (if activated).

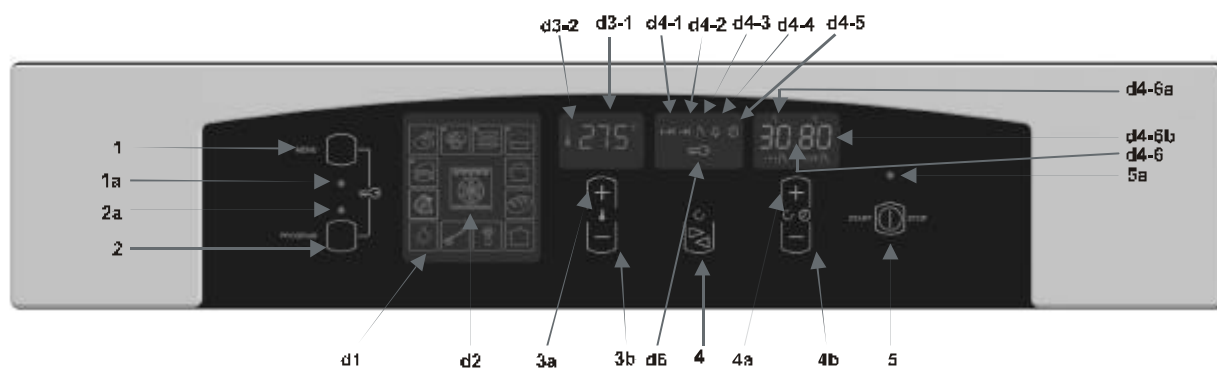

Use of oven

Alternatives with the oven on:

- Changing or setting the oven temperature (**d3-1**)
- Changing or setting oven operation time (**d4-1**)
- Changing or setting end of oven operation (**d4-2**)
- Changing or setting meat probe temperature (**d4-3**) if the meat probe is connected

Alternatives with the oven off:

- By using the food selection sensor (**1**) or mode selection sensor (**2**) you may select the type of food (**1**) or function mode (**2**), and you may change or set the oven temperature (**d3-1**), oven operation time (**d4-1**), end of oven operation (**d4-2**), meat probe (if the type of food or function mode had been selected before) (**d4-3**) alarm timer (**d4-4**) and the time of day (**d4-5**).
- changing or setting the alarm timer and the current daily time (**d4-4**).

Setting the time of day

- After the appliance is connected to the mains the display (**d4-6**) flashes »12.00« and the symbol (**d4-5**).
- By touching the sensors (**4a/4b**) you may set the exact daily time. Approximately 5 seconds after the setting is finished the symbol (**d4-5**) goes off and the display (**d4-6**) indicates the correct daily time.

Changing the current daily time

The time of day may be changed at any time (except when the end of operation mode (**d4-2**) is activated) by doing the following:

- Touch the selection sensor (**4**) and select the current time selection mode ((**d4-5**) is flashing).
- by means of sensors **4a/4b** set the current time (symbol (**d4-5**) and the time displayed are flashing (**d4-6**))
- after 5 seconds the display indicates (**d4-5**) correct current time (symbol (**d4-5**) goes off).
- in case of power failure shorter than 1 minute, the current daily time remains unchanged.

Oven illumination









- When the oven is on, the lamp is also on, regardless of the operation mode.
- If the oven is off, touch the sensor (**1**) and select the symbol "Light" (**1**), then touch the light ON/OFF sensor (**5**) turn the lamp on. Touching the ON/OFF sensor again will turn the lamp off.

Selection and setting of oven temperature

After selecting the type of food and oven function mode, by pressing the sensors **(3a/3b)** you may select the desired oven temperature in the range from 30 – 250°C (depending upon the selected operation mode) in 5°C intervals.

During the operation, oven temperature may be randomly increased or decreased within the permitted temperature range (see chart) by pressing the sensors **(3a/3b)**.

Table of data for operation mode (with a sensor 2)

Operation mode									
Preset temperature (°C)	200	160	200	170	250	160	160	150	-
Preset time (h/min)	-	-	-	-	-	-	-	-	-
Possibility of max. set temperature (°C)	250	250	250	250	250	220	220	200	-

Oven thermostat signal lamp (d3-2)

- Signal lamp is on; oven temperature is below the setting and the oven is heating.
- Signal lamp is off; the temperature in the oven has reached the set temperature.
- Signal lamp is flashing regularly; the oven is set to the end of operation mode with the adequate sensor **(d4-2)**; the preparation of food has not started as yet (the appliance automatically computes the relevant moment of starting the oven operation).

Oven operation time may be changed during the operation.

Setting the operation time

- The time of oven operation may be selected from 0 to 6 hours, in 1 minute intervals.
- After selecting the function mode and the temperature, by pressing the sensor 4 you may now select the operation time from 0 to 6 hours, in 1 minute intervals.
- Touch the selection sensor **(4)**, the display **(d4-1)** starts flashing. By touching sensors **(4a/4b)** set the desired operation time.
- Turn the oven on with the ON/OFF sensor **(5)**.
- When the set time has elapsed, the oven is switched off (signalled by the beep, oven operation time symbol **(d4-1)** and the relevant signal lamp **(5a)** are flashing).
- By touching any sensor (except the ON/OFF sensor **(5)**, which turns the sound signal off and switches the oven on) you may switch the sound signal off, otherwise it is turned off automatically after 7 minutes.

Setting the end of operation time

- This function is used when you wish to select the end of operation (cooked food) at exactly the pre-selected time.
- The function may be used only if the previously set time of operation **((d4-1)** is on).
- By touching the selection sensor **(4)** symbol **(d4-2)** flashes, and the display **(d4-6)** flashes the sum of daily current time and the oven operation time. Use the sensor **(4a)** to set the desired end of oven operation.
- Switch the oven on with the ON/OFF sensor **(5)**. The appliance awaits the start of operation (oven thermostat signal lamp symbol flashes regularly **(d3-2)**, oven operation time symbol is on **(d4-1)** and end of operation time symbol **(d4-2)** is also on.)
- The starting time is now defined automatically. At the moment the oven starts the operation, the end of operation symbol **(d4-2)** goes off, oven illumination is on, and the oven thermostat signal lamp **(d3-2)** is on until the set temperature is reached.
- Eventual immediate start of operation may be forced by simultaneous pressing of sensors **(4a/4b)** (for approximately 5 seconds).

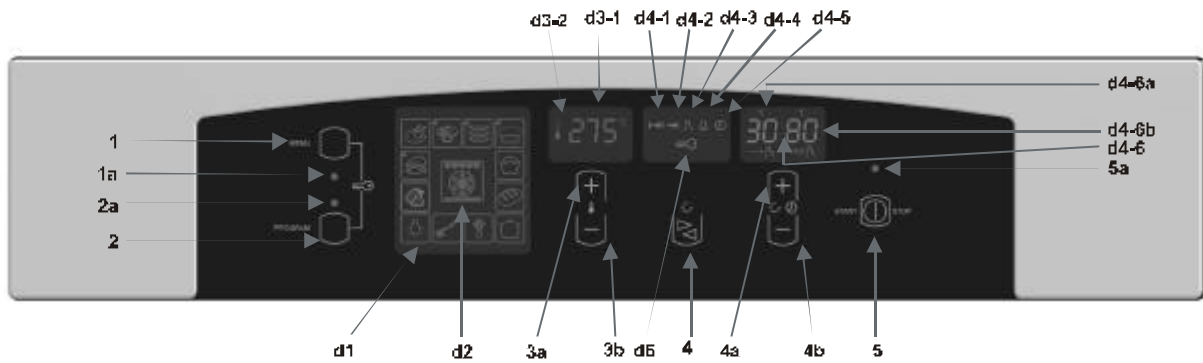

Alarm timer

This function may be applied separately, and is not in connection with the oven operation. It can be used if you wish to be warned at a pre-selected time.

- Touching the selection sensor **(4)** triggers flashing of the alarm timer symbol **(d4-4)** (the display **(d4-6)** flashes "»00:00«"). Set the desired time with sensors **(4a/4b)** in the range from 0 to 99 minutes in 1 minute intervals. The countdown starts after approximately 5 seconds, the alarm timer symbol **(d4-4)** is on, and the display **(d4-6)** indicates the current time.
- By touching the selection sensor **(4)** you may check and correct the remaining time indicated on the display **(d4-6)**.
- By simultaneous pressing of sensors **(4a/4b)** (approximately 5 seconds) the remaining time may also be set to »00:00«.

Safety sensor block

This function is activated in case you may wish to block the oven operation control (safety of children).

- It is activated by simultaneous pressing of the food selection sensor **(1)** and the function mode sensor **(2)** for approximately 5 seconds.
- The blocked operation symbol is on **(d6)**.
- To deactivate blocked operation mode press both sensors (the blocked operation symbol **(d6)** goes off).
- By pressing the ON/OFF **(5)** sensor the oven may be switched off at any time, despite the activated blockage of operation.

Programmed roasting with the meat probe

This function mode requires the setting of the temperature to be developed within the centre of the meat portion. The setting range is between 30°C and 99 °C. The temperature is controlled by the meat probe.

Connection of the probe

Insert the meat probe plug into the socket and push the probe into the meat. The socket is located in the upper front left hand side of the oven. It has a metal plug which must be pulled out and reinserted after roasting.

WARNING

Be careful not to touch the heating element with the probe during roasting!

This mode of roasting is suitable for appropriately large portions of meat, preferably boneless, since the bones impede the temperature control and yield incorrect temperature readings. Chicken and rabbits are not appropriate for meat probe roasting.

Recommended temperatures of meat core

Pork Roast	85°C
Roast Beef	80°C
Veal Roast	75°C
Beef Fillet	40-50°C

Procedure

- Connect the probe and push it into the meat.
- Select the appropriate roasting mode by the food selection sensor **(1)** or by the function mode sensor **(2)**. The display **(d4-6a)** indicates the actual meat temperature, while the display **(d4-6b)** indicates the preset temperature of 80°C. This value may be changed at any moment by pressing sensors **(4a/4b)** in the temperature range between 30 and 99°C in 1°C intervals.
- Switch the oven on with the ON/OFF sensor **(5)**. The meat probe starts measuring the core temperature, which is increasing.
- Once the set temperature of the meat core is obtained, the oven stops operating, and the sound signal indicates the end of operation. The beep may be turned off by touching any of the sensors (except for the ON/OFF sensor **(5)**, which turns the sound signal off but switches the oven back on).
- **If the oven is not switched off it will switch back on after some time (when the actual temperature falls below the preset value). This way the actual temperature of the food is maintained.**
- Pull the probe from the meat and pull the plug from the socket. The display **(d4-6)** indicates the actual current time of day.

Use of meat probe in combination with the timer functions (for experienced users)

When using the meat probe you may also set the operation time or the end of operation, as described in previous paragraphs. But always remember:

- If you use the preset time operation mode **(d4-1)** and set the desired period, the oven will stop operating when the time elapses, irrelevant of whether the actual temperature of the food has reached the preset temperature. Therefore the preset operation time must always be somewhat longer than the time necessary for food to reach the appropriate temperature.
- The same procedure is identical for the end of operation function mode **(d4-2)**.
- This combination is suggested once the user has gained certain experience regarding the time required for particular type and quantity of food to be roasted, appropriately roasted at a preset temperature.
- According to the information gained with experienced use, you may set the oven operation time **(d4-1)** somewhat longer than required, thereby also successfully using the end of operation mode **(d4-2)**.

Note

With the meat probe connected the display always indicates the actual and the selected temperature (except with the oven off, when no function mode is selected).

In case you had already selected the particular type of food with the food selection sensor **(1)** and the preset operation time, the time setting will be rendered void at the moment of connecting the probe. This happens also with all other cases. The time may of course be preset again.

If the oven is off and the meat probe is connected, the meat probe symbol starts flashing **(d4-3)** as an alert that the probe is active.

CAUTION

Use only the meat probe designed for this particular oven.

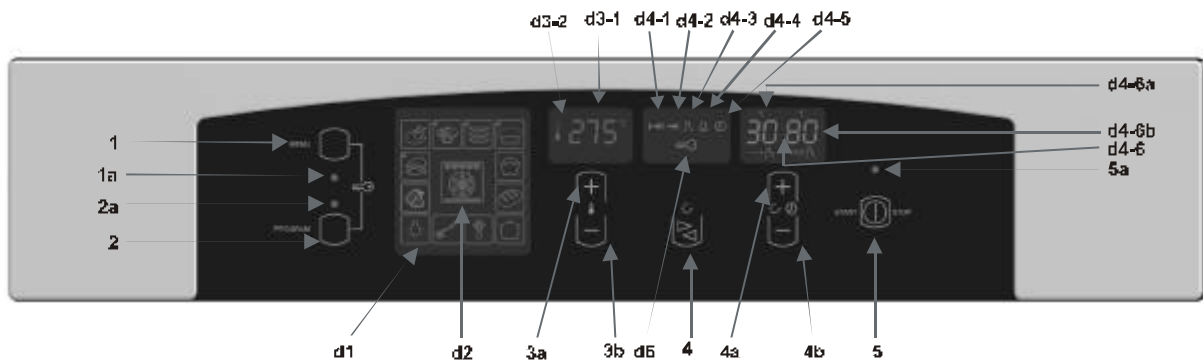

The oven may be controlled in two ways

- 1 By selecting the type of food
- 2 By selecting the function mode

Switching between the two control modes

- **The oven is off:**
 - If mode (1) is selected, you may switch to mode (2) by pressing the sensor (2) twice (if oven selector is on illumination only, one touch of the sensor is enough). All settings relevant to mode 1 are erased.
 - Similarly you may switch from mode (2) to mode (1) (in such cases touch sensor (1) twice).
- **The oven is on:**
 - Switching is not possible.
 - If you still wish to change the function mode, first switch the oven off by touching the ON/OFF sensor (5) (the signal lamp (5a) is flashing) and then select the desired function mode.























- While the signal lamp (5a) is flashing, you may change settings at random. If the oven is not switched on in approximately 15 seconds after the last touch of any sensor, it will switch off automatically.
- After the oven is switched on (signal lamp 5a is lit) you may revoke the setting by consequent touch of the ON/OFF sensor (5) (signal lamp 5a is flashing) and the oven will switch off automatically after approximately 5 seconds.

Food selection mode

This mode is appropriate for the preparation of the chosen food with automatic setting of mode, temperature and operation time.

- Touch the food selection sensor and select the type of food (appropriate symbol and relevant function mode are lit, as well as the temperature and operation time)
- Touch the ON/OFF sensor (5) to start the operation. **After the expiry of the set time the oven is switched off automatically.**
- In case of different quantity of food, you may still use this mode, but you must change the operation time and the temperature accordingly.
- You may however use the end of operation function (see »End of oven operation« section).

Table of data for selected food (with a sensor 1)

Food type											
	Pork chops whole	Pork chops fish	Chicken	Pizza	Biscuits and muffins	Rising of dough	Raisin cake	Bread	Roast beef	Defrosting	Cleaning
Function mode											
Preset temperature (°C)	195	250	170	200	160	40	160	200	220	-	50
Preset time (h/min)	1:50	0:25	1:00	0:10	0:25	-	1:00	1:15	1:50	-	0:30
Possibility of max. set temperature (°C)	250	250	250	250	250	220	250	250	250	-	220
Weight (in kg)	1	4x0,2	1	1x0,4	3x0,3	-	1,1	1	1	-	-











Operation mode selection

This mode is used when you wish to prepare any unspecified type and quantity of food. You may select the function mode, oven temperature, operation time, time when you wish the food to be ready, or roasting with the meat probe and alarm timer.

 Once the desired function mode is selected, and other settings regulated, the oven must be switched on by pressing the ON/OFF sensor **(5)** within 15 seconds, or else all settings are rendered void.

The appropriate function mode is selected by pressing the mode selection sensor **(2)** (the display indicates the selected function mode).

Table for cooking selected food

Symbol	Dish	Temperature (°C)	Time h/min.)	Quantity (kg)	Guide (from below)	Caution
	Pork chops roast	195	1:50	1	3	Roasting in small pan on the grid (☐).
	Pork chops, fish	250	0:25	4x0,2	5	Roasting on the grid (dripping pan is placed one level below) with door close. Turn the meat around halfway through roasting (☐).
	Chicken	170	1:00	1	3	Roasting on the grid in middle level guide, dripping pan is placed one level below (☐).
	Pizza	200	0:10	1x0,4	3	Preheating for 8 minutes, roasting in shallow pan (☐).
	Biscuits, brownies	160	0:25	3x0,3	2,4	Preheating 5-6 minutes, roasting in shallow pans at two levels simultaneously (☐).
	Rising of yeast dough	40	-	-	2	Preheating for 3 minutes. Dough rises in a bowl, placed on the grid (☐).
	Raisin cake	160	1:00	1	2	Baking in dark raisin cake mould on the grid (☐).
	Bread	200	1:15	1,5	3	Baking in shallow pan. (☐).
	Roast beef	220	1:50	1	2	Roasting or stewing of beef in covered dish, placed on the grid. (☐).
	Defrosting	-	-	-	3	Place the frozen food on the grid. Dripping pan is placed in the guide below. (☐).
	Cleaning	50	0:30	0,4l vode	2	Pour water in deep pan. (☐).

Switch on the preheating in particular roasting/baking mode prior to its programming, because the preset cooking time does not include preheating.

Important warnings!

- Never put aluminium foil on the bottom of the oven, and do not place any crockery upon it. The excessive heat may damage the oven enamel.
- Juices dripping from the baking pan may produce stains on the enamel, which are very hard to remove.

Operation

Oven is controlled by the function knob and the temperature selection knob.

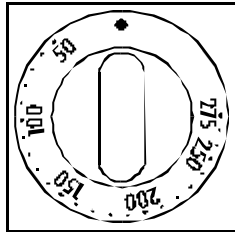

Temperature selection knob

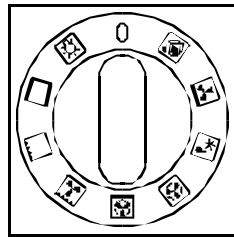

Function knob

Modes of operation

The oven may be used in the following modes.

Oven light



Some models have installed two lamps for oven lighting; one at the top of the rear wall and the second at the middle of the right-hand side wall. The oven lights may be switched on independently, without any other function. This is handy during cleaning, or when switched off and using the remaining oven heat. During all other oven functions the illumination is automatically switched on with the selection of a particular function.

Conventional



Elements from the upper and the lower side uniformly heat the exposed food. Baking and roasting is possible only at single level.

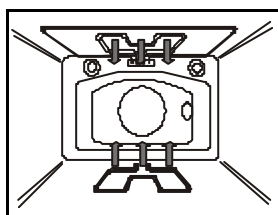

Grill



Heat comes directly from the grill element, located at the oven ceiling. The grill function is especially suitable for preparing steaks, sausages, T-bones, pork chops, etc.

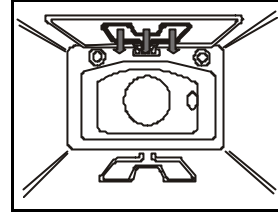

Fan Grill



Grill element and fan operate simultaneously. This mode is appropriate for roasting and grilling of larger portions of meat or poultry at one level. It may also be used to obtain crisp skin on your roast.

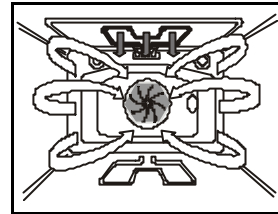

Fan Forced Plus Traditional



Both the lower element and hot air fan are in operation. This mode is most appropriate for baking pizza. It may also be used for baking moist or heavy cakes at two levels, fruit cakes or cheese soufflés.

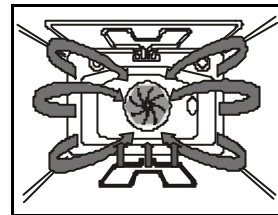

Fan Forced



The fan at the rear forces the air around the roast or pastry. It is suitable for roasting and baking at more than one level.

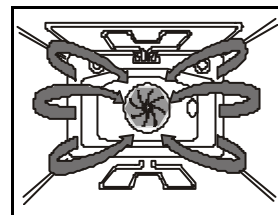

Fan Defrost



This mode uses the fan and no element to circulate air around the cavity. It is used for slow defrosting of food.

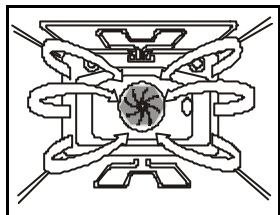

Traditional with Fan



Both the lower element and fan are in operation. This mode is useful for baking low pastry and preparation of preserved fruit and vegetables. Use the first guide level from the bottom, and not too high pans, to allow the air to circulate along the upper side of the food.

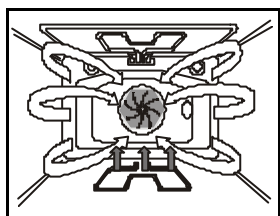

Traditional/Aqua Clean



Heat is applied only at the bottom of the oven. Use this option for browning the under side of food (baking heavy, moist pastry with fruit dressing). The temperature selection button in such cases may be selected as required. Lower element may also be used for cleaning the oven. You will find details in the section Cleaning and Maintenance.

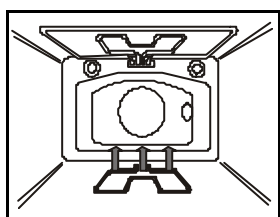

Oven guide levels

Baking pans and accessories (oven grid, grease receptacle, baking tray, etc.) may be inserted into the oven in 5 guiding levels.

Appropriate levels are indicated in the tables that follow.

Always count levels from the bottom upwards! Guides may be of three types, depending on the model. Telescopic guides are inserted in the 2nd, 3rd and 5th level. In case of wire guides, the grid and the baking pans must always be inserted in the guide slides.

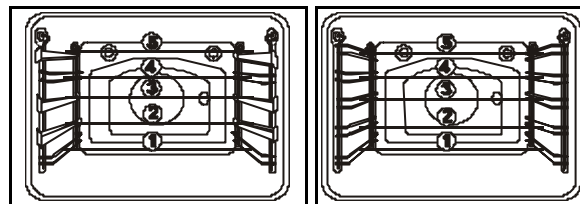

Oven accessories

(differ according to different models)

Oven grid shelf for placing pans and trays, or for food to be prepared using the grill.

Flat biscuit tray for baking cake and biscuits.

Deep Baking Pan

For moist cakes, roasting or for intercepting dripping of oil or grease.

Note! If the deep roasting pan is used for intercepting the dripping juice and grease during roasting, it should not be inserted into the first bottom level guide.

The rear wall of the oven is coated with **catalytic coating** which can be installed or removed by a qualified technician only.

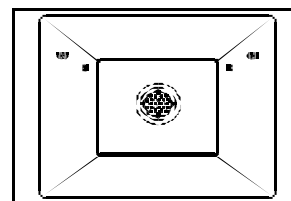
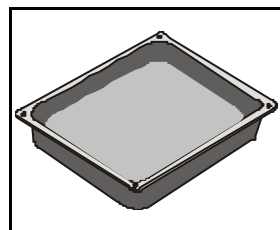
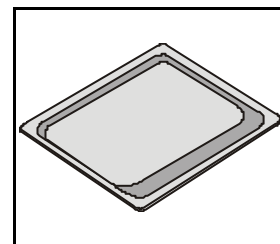
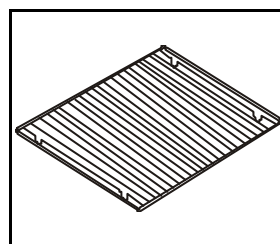

Telescopic slide guides

(certain models only)

Note! Telescopic slide guides and other oven accessories might get very hot! Use kitchen gloves or other suitable protection!

Telescopic slide guides are located inside the oven to the right and to the left in three different levels.

- To insert the grid, baking or roasting pan, first slide out the telescopic guides for one particular level.
- Place the tray or pan on the guides and push them back completely into the oven.

Close the oven door only after you have pushed the telescopic guides into the oven.

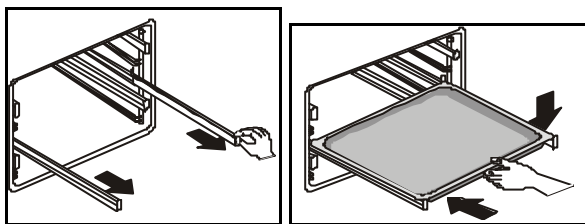

Grease filter

The removable grease filter at the rear panel of the oven protects the fan, elements and interior cavity of the oven from accidental staining with grease. Always insert the filter when roasting or grilling, and remove the filter when baking pastry. The grease filter may cause unsuccessful baking of some kinds of pastry.

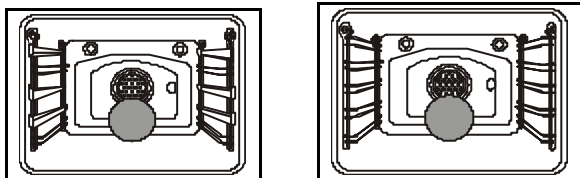

Baking pastry

The most appropriate position for baking is by using both upper and lower elements.

Note! Grease filter must always be removed!

Warnings

- When baking pastry, strictly follow the instructions regarding the selection of guide level, temperature and baking time. Do not rely on any previous experience, because information indicated in the baking tables have been determined and tested specifically for this particular type of oven.
- If you are unable to determine the exact type of cake in the tables, use the information available for the next most similar type of cake.

Baking with Traditional Mode

- Use only a single guide level.
- This baking position is particularly suitable for baking dry pastry, bread and teacakes. Use dark baking pans. Light pans reflect heat and pastry is not adequately browned.
- Always place baking pans on the wire rack. Remove the wire rack only if baking in the flat biscuit tray, supplied with the appliance.
- Preheating shortens the baking time. Do not put the cake in the oven until proper temperature is obtained, and until the red signal lamp goes off for the first time.

Baking with Fan Forced Mode

- This mode of baking is especially suitable for baking at multiple levels, for moist pastry and fruitcakes.
- The temperature is usually lower than baking with upper/lower element (see Baking Table).
- Moist pastry (i.e. fruitcake) may be baked at maximum two levels at the same time, because of excessive humidity.
- Different cakes may be baked together if the necessary temperature is approximately the same.
- Baking time may be different for different pastry, so you may have to take one pan out before the others.
- Cookies, like for example muffins, should be of equal size and thickness. Uneven cookies are baked unevenly.
- If you bake more than one cake at the same time, it may produce excessive steaming in the oven and condensation at the oven door.

Baking tips

Is pastry baked?

Pierce the cake with a skewer at the thickest part. If the dough does not stick to it, the cake is baked. You may switch off the oven and use the residual heat.

Pastry has fallen

Check the recipe. Use less fluids next time. Follow the mixing times, in particular when using powered kitchen mixers.

Pastry is too light below

Use a dark baking pan next time, or place the pan one level lower, or switch on the lower element a short time before the completion.



Cheesecake is undercooked

Next time reduce the baking temperature and extend the baking time.

Warnings regarding the baking tables:

- The tables indicate the temperature range. Always select lower temperature first. You may always increase the temperature in case pastry needs more baking.
- **Baking times** are indicative only. They may vary in dependence of individual characteristics.
- The asteric indicates that the oven requires preheating.

Pastry Baking Table

Type of pastry	Guide level (from down upwards)	Temp. (°C) 	Guide level (from down upwards)	Temp. (°C) 	Baking time (in min.)
Sweet pastry					
Raisin cake	2	160-170	2	150-160	55-70
Ring cake	2	160-170	2	150-160	60-70
Tree cake (tart form)	2	160-170	2	150-160	45-60
Cheese cake (tart form)	2	170-180	3	150-160	60-80
Fruit cake	2	180-190	3	160-170	50-70
Fruit cake with icing	2	170-180	3	160-170	60-70
Sponge cake*	2	170-180	2	150-160	30-40
Flake cake	3	180-190	3	160-170	25-35
Fruit cake, mix dough	3	170-180	3	150-160	50-70
Cherrycake	3	180-200	3	150-160	30-50
Jelly roll*	3	180-190	3	160-170	15-25
Fruit flan	3	160-170	3	150-160	25-35
Plait bun	2	180-200	3	160-170	35-50
Christmas cake	2	170-180	3	150-160	45-70
Apple pie	2	180-200	3	170-180	40-60
Puff pastry	2	170-180	3	150-160	40-60
Salted pastry					
Bacon roll	2	180-190	3	170-180	45-60
Pizza*	2	210-230	3	190-210	30-45
Bread	2	190-210	3	170-180	50-60
Rolls*	2	200-220	3	180-190	30-40
Cookies					
Caraway roll	3	170-180	3	150-160	15-25
Biscuits	3	170-180	3	150-160	20-30
Danish pastry	3	180-200	3	170-180	20-35
Flaky pastry	3	190-200	3	170-180	20-30
Cream puff	3	180-200	3	180-190	25-45
Deep frozen pastry					
Apple pie, cheese pie	2	180-200	3	170-180	50-70
Cheese cake	2	180-190	3	160-170	65-85
Pizza	2	200-220	3	170-180	20-30
Chips for oven*	2	200-220	3	170-180	20-35
Potato fries for oven	2	200-220	3	170-180	20-35

Roasting

Best results are obtained with the engagement of both upper and lower elements.

Note! When roasting always insert the grease filter!

Tips regarding roasting pans

- Use light enamel pans, temperature resistant glass pans, clay dishes or wrought iron dishes.
- Stainless steel dishes are not recommended because they excessively reflect heat.
- Cover your roast or wrap it in foil. It will preserve its juice and the oven will remain cleaner.
- If you leave the pan uncovered, the roast will be cooked sooner. Roast large portions of meat directly on the grid, with intercepting pan underneath.

Attention when roasting!

Roasting tables indicate suggested temperatures, guide level and roasting times. The roasting time largely depends upon the type of meat, its size and quality, therefore you may expect some variations.



- Roasting of large portions of meat may produce excessive steaming and dew formation at the oven door. This is quite normal, and does not affect the operation of the oven. However, after the completion of roasting wipe the oven door and the glass thoroughly.
- At approximately the middle of the indicated time turn the roast around, especially if you use the deep roast dish.
- When roasting on the grill grid, place the grid in the deep roasting pan and insert both into the sliding guide. The bottom pan will intercept dripping fat.
- Never leave roast to cool in the oven, as it might produce dew and corrosion of the oven.

OVEN ROAST PROBE

TYPE OF MEAT	APPROXIMATE COOKING TIME	OVEN TEMPERATURE °C	ROAST PROBE SET TEMPERATURE °C	TENDERNESS
Beef	60 minutes per kg	170 – 200	60 - 65 65 - 75 75 - 85	Rare Medium Well-done
Lamb	60 minutes per kg	170 – 200	65 - 75 75 - 85	Medium Well-done
Hogget	70 minutes per kg	170 – 200	75 - 85	Well-done
Pork	90 minutes per kg	170 - 200	80 - 85	Well-done
Veal	90 minutes per kg	170 - 200	65 - 75	Well-done
Whole Chicken	90 minutes per kg	170 - 200	75 - 85	Well-done
<p>Note: These cooking times and temperatures are recommended using the <i>Fan Forced</i> mode. Pork and Veal should normally be well done.</p>				

*These Cooking Charts are intended as a guide only.
Temperatures and cooking times may be varied to suit individual tastes.*

Roasting Table

Type of meat	Weight (in grams)	Guide level (from bottom up)	Temp. (°C) 	Guide level (from bottom up)	Temp. (°C) 	Roasting time (in min.)
Beef						
Beef loin	1000	2	200 -220	2	180-190	100-120
Beef loin	1500	2	200-220	2	170-180	120-150
Roast beef, rare	1000	2	220-230	2	180-200	30-40
Roast beef, well done	1000	2	220-230	2	180-200	40-50
Pork						
Pork roast with skin	1500	2	180-190	2	170-180	140-160
Flank	1500	2	190-200	2	170-180	120-150
Flank	2000	2	180-200	2	160-170	150-180
Pork loin	1500	2	200-220	2	160-170	120-140
Meat roll	1500	2	200-220	2	160-170	120-140
Pork cutlet	1500	2	180-200	2	160-170	100-120
Minced meat roast	1500	2	210-220	2	170-180	60-70
Veal						
Veal roll	1500	2	180-200	2	170-190	90-120
Veal knuckle	1700	2	180-200	2	170-180	120-130
Lamb						
Lamb prime ribs	1500	2	190-200	2	170-180	100-120
Mutton bladebone	1500	2	190-200	2	170-180	120-130
Venison						
Hare ribs	1500	2	190-210	2	180-190	100-120
Hare bladebone	1500	2	190-210	2	170-180	100-120
Boar ham	1500	2	190-210	2	170-180	100-120
Poultry						
Chicken, entire	1200	2	200-210	2	180-190	60-70
Hen	1500	2	200-210	2	180-190	70-90
Duck	1700	2	180-200	2	160-170	120-150
Goose	4000	2	160-170	2	150-160	180-200
Turkey	5000	2	150-160	2	140-150	180-240
Fish						
Fish, entire	1000	2	200-210	2	170-180	50-60
Fish soufflé	1500	2	180-200	2	150-170	50-70

Grilling and browning (barbecue)



- **Take extra precautions when grilling. Intensive heat from the grill element makes the oven and accessories extremely hot. Use protective gloves and barbecue accessories!**
- **Piercing a roast may produce spurting of hot grease (ie sausages). Use long grill tongs to prevent skin burns and protect your eyes.**
- **Supervise the grill at all times. Excessive heat may quickly burn your roast and provoke a fire!**
- **Do not let the children in the vicinity of the grill.**

The grill element is in particular suitable for the preparation of low-fat sausages, meat and fish fillets, steaks, and browning and crisping the roast skin.

Tips for grilling

- **Grilling should be carried out with the oven door closed.**
- Grilling tables indicate the recommended temperature, guide levels and grilling times, which may vary according to the weight and quality of meat.
- **Always insert the grease filter when grilling.**
- Grill element should be pre-heated for 3 minutes.
- Oil the grill grid before placing the food, otherwise food may stick to the grid.
- Place the meat upon the grid, then place the grid upon the grease interception pan. Insert both trays into the oven guides.
- Turn the meat around after half of the roasting time has expired. Thinner slices will require only one turn, for larger portions you might need to repeat the procedure. Always use barbecue tongs to avoid losing excessive juice from meat.
- Dark beef meat is grilled quicker than lighter pork or veal.
- Clean the grill, the oven and the accessories after each use.

Grill table

Type of meat for grill	Weight (in grams)	Guide level (from bottom up)	Temp. (°C) 	Temp. (°C) 	Grill time (in min.)
Meat and sausages					
2 beefsteaks, rare	400	5	250	-	7-9
2 beefsteaks, medium	400	5	250	-	10-14
2 beefsteaks, well done	400	5	250	-	16-20
2 pork scrag fillets	350	5	240	-	18-20
2 pork chops	400	5	240	-	18-20
2 veal steaks	700	5	240	-	16-20
4 lamb cutlets	700	5	240	-	10-14
4 grill sausages	400	5	240	-	8-10
2 slices of meat cheese	400	5	240	-	7-10
1 chicken, halved	1400	3	-	210-220	28-33 (1. side) 23-28 (2. side)
Fish					
Salmon fillets	400	4	240	-	8-12
Fish in aluminium foil	500	4	-	220	10-13
Toast					
4 slices of white bread	200	5	240	-	1-2
2 slices of wholemeal	200	5	240	-	1-2,5
Toast sandwich	600	5	240	-	1,5-3
Meat/poultry					
Duck	2000	1	-	150-170	80-100
Chicken	1000	3	-	160-170	60-70
Pork roast	1500	3	-	140-160	90-120
Pork scrag	1500	3	-	140-160	100-180
Pork knuckle	1000	3	-	140-160	120-160
Roast beef/beef fillet	1500	3	-	170-180	40-80

Preserving of fruit and vegetables

Use the bottom element mode together with the fan .

- Prepare the food for preserving and jars in the usual manner. Use conventional jars with glass cover and rubber gasket. Never use jars with threaded or tin covers, or tins. Jars should be of the same size, filled with the same type of food and well tightened. You may place up to six one-litre jars.
- Use only fresh groceries.
- Pour approximately one litre of water into the deep roasting pan, to produce the required humidity. Place the jars into the oven without touching the oven walls (see fig.). Cover the jars with a wet paper to protect the rubber gaskets.

- Insert the pan with jars into the second guide from bottom up. Set the temperature regulation knob to 180°C. Pre-heating of the oven is not necessary.
- Watch the jars all the time. Once the liquid in the jars starts boiling, follow the instructions from the Preserving Table.

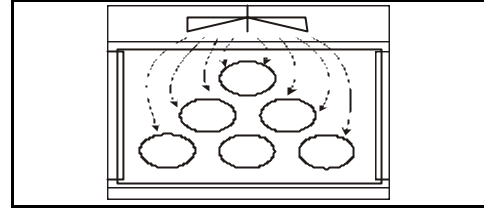

Preserving table

Type of fruit or vegetables	Quantity	Bottom element and fan, 180°C, until boiling 	After boiling	Cooling time
Fruit				
Strawberry	6x1 litre	around 30 min	switch off	15 min
Stone Fruit	6x1 litre	around 30 min	switch off	30 min
Stewed fruit	6x1 litre	around 40 min	switch off	35 min
Vegetables				
Pickles	6x1 litre	30 to 40 min	switch off	30 min
Beans, carrots	6x1 litre	30 to 40 min	reduce to 130°C 60 - 90 min	30 min

Defrosting

Defrosting of food may be accelerated by circulating air within the oven. To do this, set the oven to the position "Defrost" .

Note! In case of accidental engagement of the temperature regulation knob the red light switches on, but no element is active.

- You can defrost frozen cream cakes, butter cream cake, biscuits, pastry, bread and rolls, as well as deep frozen fruit.
- For reasons of hygiene do not defrost meat and poultry in the oven.
- If possible, stir the food or turn it over for better and more uniform defrosting.

Cleaning and maintenance

Never clean the appliance with a pressurised hot steam cleaner!

Before cleaning switch the oven off and let it cool down completely.

Front side of the casing

For cleaning of front part of the oven use the usual cleaning agents and follow the manufacturer's instructions.

Never use any aggressive cleaning agents or dish cleaning accessories which may cause scratches.

Stainless steel front

(certain models only)

Clean the surface with mild detergent (soap) and a soft sponge which will not scratch. Never use aggressive cleaners or solvents, or else you may damage the surface.

Enamel coated and plastic surfaces

(certain models only)

Clean the knobs and handles with a soft cloth and liquid cleaners, intended for use on smooth enamel surfaces.

Aluminium coated surfaces

Aluminium coated surfaces of the appliance (front) should be cleaned with liquid non-abrasive agents and a soft sponge. You may also use cleansing agents intended for such surfaces, and follow the manufacturer's instructions.

CAUTION: Such surfaces must never come in contact with oven cleaning sprays, because they visibly and permanently damage aluminium surfaces.

Oven

The oven may be cleaned by conventional methods (using oven cleaners and sprays).

The following procedure is recommended for regular cleaning of the oven (after each use):

Turn the mode selection button to the position .

Set the temperature control button of the cold oven to 50°C. Pour ¼ litre of water into the baking pan and insert it into the bottom grid guide. After thirty minutes the food residues on the enamel coating will be softened, and can be easily wiped off with a moist cloth.

Otherwise respect the following cleaning tips:

- Cool the oven completely before cleaning.
- The oven and accessories must be cleaned after each use, or else stains may get burnt on.
- The interior glass should only be cleaned with a non-abrasive oven cleaner.

- The seal surrounding the interior oven glass should be free from any cleaner.
- Baking trays should NOT be placed in the dishwasher. Wash in warm soapy water.
- Oven walls, sprayed with oil from roasting, are best cleaned with warm water and a mild detergent when the oven is still tepid.
- A hard and heavily stained oven should be cleaned with special oven cleaning agents. Rinse the cleaner thoroughly and remove any detergent remaining before the next use.
- Never use aggressive cleaners, like polishing agents, dish cleaning accessories, corrosion inhibitors, or any other devices that might cause scratches.
- Coated, stainless steel, zinc-coated surfaces or aluminium parts must not come into contact with oven sprays, as they may cause damage or discolouration. The same goes for the thermostat probe (if the oven is equipped with one) and exposed elements on the oven ceiling.
- When purchasing cleaning agents remember the environment, and strictly follow the manufacturer's instructions.

Catalytic coating of the oven

- Catalytic enamel is soft and sensitive to rubbing. Therefore we warn against the use of abrasive cleaning agents and sharp objects.
- Rough catalytic enamel speeds up disintegration of grease and other filth. Smaller stains that remain after cooking usually disappear during the next use of the oven. As a rule, the stains disappear at temperatures above 220°C, while at lower temperatures their disappearance is only partial.
- The self-cleaning power of catalytic liners gradually deteriorates. We suggest replacement of liners after a couple of years of regular use.

Some useful hints

- When roasting a large portion of fatty meat we recommend that you wrap it in aluminium foil or put it in a suitable roasting bag to prevent the grease from splashing all over the oven.
- Place the drip pan underneath the grid when using the grill.

Removing wire and telescopic guide grids

Telescopic side racks or wire racks may be removed to facilitate the cleaning of the oven. Side racks are removed by swinging the bottom side inwards and unhooking them.

Clean the side racks and telescopic guides only with conventional detergents.

Telescopic racks must not be washed in a dishwasher.

Note! Never lubricate the telescopic racks!

To reinsert, repeat the procedure backwards: slide them into the holes and swing downwards.

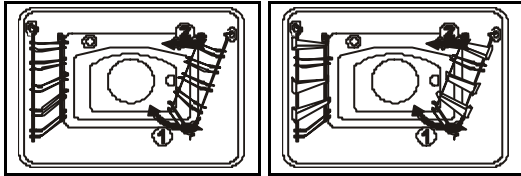

Accessories

Accessories, like the biscuit tray, oven tray, etc. are cleaned with hot water and the usual detergent.

Special enamel

The oven, interior door lining, baking tray and grease interception pan are coated with special enamel, with smooth and resistant surface.

This special coating facilitates cleaning at room temperature.

Grease filter

Clean the grease filter after each use with a soft brush in hot water with some detergent, or wash it in the dishwasher.

Removing oven door with a single axe hinge

Open the door completely and turn the removable locks backwards (see fig). Then close the door slowly and let the locks fit to the notches. At an angle of about 15° lift the door slightly up and pull the door from the hinge supports (fig. 2).

For reinserting the door repeat the procedure backwards. Insert the door at an angle of about 15° into the hinge supports by pushing them forward and downwards, so the hinges lock into their slots (fig. 3). Check if the hinges are locked into their respective slots.

Now open the door completely and turn the removable locks into their original position. Close the door slowly and check if they close properly (fig. 4). If you have trouble closing the door, check if the hinges are properly inserted into their slots.

Attention! Never let the hinge locks spring out, as the springs are strong and may cause injuries.

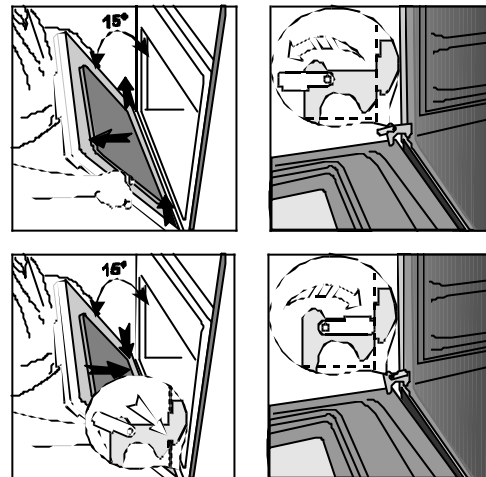

Troubleshooting guide

Any unskilled attempt to repair the appliance is extremely dangerous as it can cause electric shock and short circuit. To avoid such injuries any repairs must be performed by qualified personnel only.

However, there are some minor faults which may be easily removed by the user, in accordance with the instructions that follow.

Important!

If the malfunction of the appliance was caused by improper use, the service visit during the warranty period is not free of charge.

Following are some simple suggestions on how to repair minor faults:

Program clock indicates faulty values or switches on and off intermittently...

Switch the oven off, disconnect it from the mains for a few minutes (unlock the fuse or switch off the main switch), then reconnect it to the mains and set the correct daily time.

Program clock display is flashing...

There may have been a power failure, or the oven has been connected to the mains for the first time. All settings are erased. Set the correct time of day to be able to activate the oven. After operating in automatic mode, the oven switches off, the display indicates time, and the beep is heard. Take the food from the oven, set the temperature selection knob and the mode knob into their original positions. Select the "Manual mode", and use the oven in a conventional mode (without programming).

Signal lamp does not turn on....

- are all the required switches properly activated?
- is the mains power fuse burned?
- is the temperature regulator properly set?

Fuses often burn out...

- Call the serviceman or your electrician!

Oven light is not on....

- The replacement of oven bulb/s is described in the section "Replacement of parts".

Oven does not heat up...

- is the mains power fuse burned?
- is the temperature regulator set correctly?
- did you set the oven to the conventional mode after using it in the automatic mode (programmed)? Switch the mode button to the position "Manual mode".

Baking results are disappointing...

- did you remove the grease filter?
- did you follow the instructions and warnings from the section "Baking"?
- did you strictly follow the information from the baking table?

Replacement of parts

The oven light bulb casing is under tension. Danger of electric shock!

Before replacing the oven bulb switch off the oven and cut it from mains by removing the mains power fuse or disconnect the protective device. Remember that the bulb is regarded as consumable item and is not covered by the warranty.

Other accessories

The oven tray, biscuit tray, etc. may be ordered from by contacting your nearest Kleenmaid Store on 13 13 08. When ordering please quote the code and the type or model of the appliance. Control knobs are removed by pulling outwards and replaced by pushing the new ones back in place.

Oven light bulb

The bulb for replacement should meet the following specifications:
E 14, 240 V, 25 W, 300°C.

Unscrew the glass cover by turning it in an anti-clockwise direction and replace the bulb. Screw the glass cover back in place.

In case of side light remove the glass cover by inserting a screwdriver into the slot and move in the direction of the arrow. (see Fig.)

Remember that the bulb is regarded as a consumable item and is not covered by the warranty.

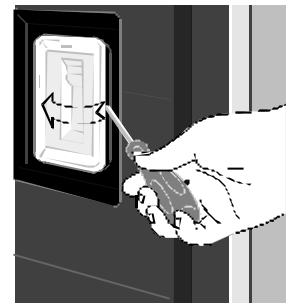
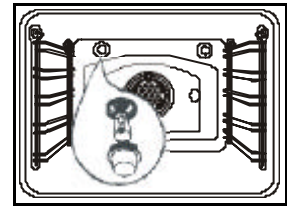
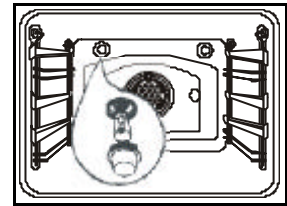

Instructions for installation and connection

Safety precautions for installation

- Installation must be carried out only by qualified personnel.
- The electric installation shall be equipped with a safety device, able to disconnect the appliance from mains in all wires, with the distance between contacts of not less than 3 mm in open position. Good protection is provided by the LS-switches and/or fuses.
- The connection may be carried out by rubber mains lead (type HO5RR-F with green/yellow earth wire), PVC insulated mains lead (type HO5VV-F with green/yellow earth wire) or other cables of equal or better quality.
- Panels, glue and furniture lining from artificial materials, adjacent to the appliance must be temperature resistant (>75°C), otherwise they may become warped or discoloured.
- Remove any packaging materials (foils, artificial foam, nails, etc.) from the reach of children. They present potential danger. Children may swallow small parts or suffocate.

Installation of electric oven

- Panels and furniture lining of the kitchen cabinet into which the oven is installed must be treated with temperature resistant adhesives (100°C), or else they may be discoloured or warped because of inadequate temperature resistance.
- Before installation you must remove the rear panel from the kitchen cabinet in the area of installation.
- Follow the exact dimensions of the installation opening, indicated on the illustration.
- The bottom of the kitchen cabinet (max 530 mm) must always be shorter than the side panels in order to provide adequate ventilation.
- Level the kitchen cabinet using a spirit level.
- The kitchen cabinet into which the oven is installed must be fixed to the adjacent cabinet to ensure adequate stability.
- Push the appliance into the cabinet so that screw guides located in the oven frame holes stay on the cabinet side panels. Be careful not to tighten the screws excessively because you may damage the cabinet sides or the enamel of the appliance.

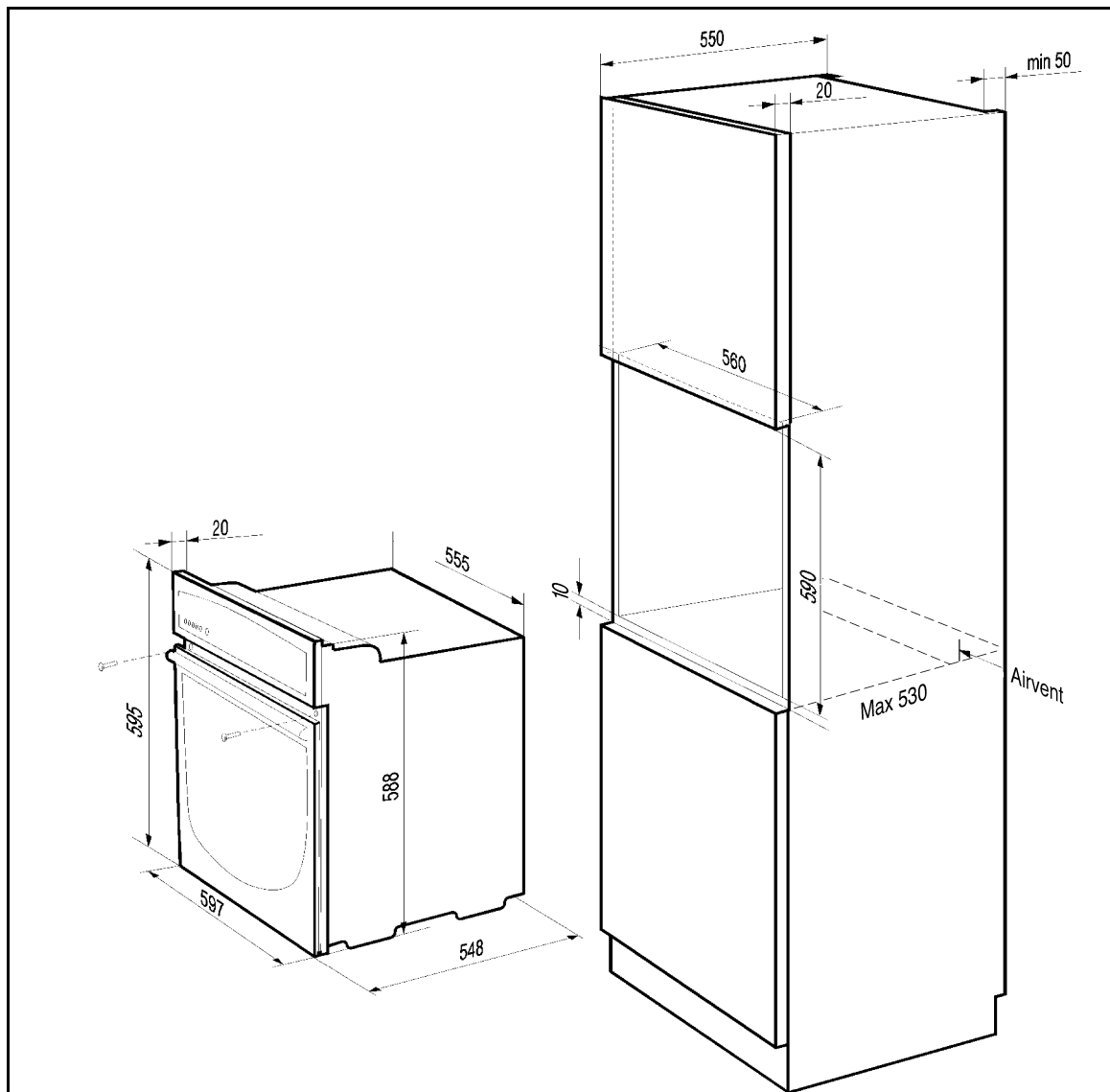
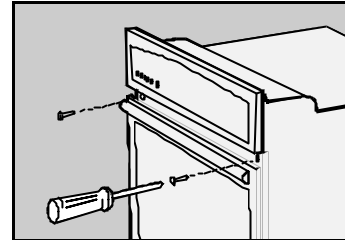

Electric connection



Electric connection must be carried out by qualified service personnel only!
Wrong connection may

permanently

damage parts of the appliance and render your warranty void!

Mains voltage of the user (240 V) must be verified with the measuring device!

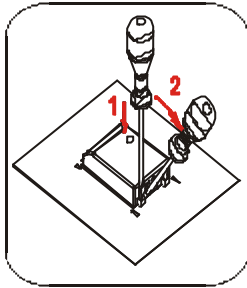

- Before attempting the connection, check whether the voltage indicated on the rating plate corresponds to the actual mains voltage.
- Mains lead should be minimum 1.5 m long, so that it may be plugged into the socket before the appliance is completely pushed to the wall.
- Earthing wire should be installed in such manner to be the last one pulled out in case the safety relief device of the mains lead should fail.

Connection

- Using a screwdriver open the connector cover at the rear of the appliance. Release two locks located at either side of the connector bottom.
- Mains lead must be led through the relief safety device, protecting the mains lead cable from disconnection.
- Tighten the relief device securely and close the connector cover.

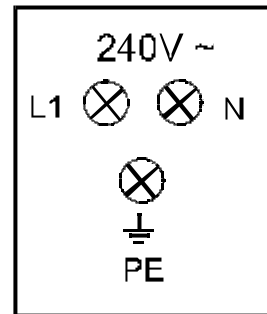

Colour code

L1, L2, L3 = exterior live wires, usually coloured black, black, brown.

N = neutral

The colour is usually blue.

Beware of the correct N-connection!



PE = earthing wire

The colour is green/yellow.

Technical information

Type-model	TO600X/A (EVP454-431E)
Dimensions of the appliance (height/width/depth) (mm)	588x555x548
Dimensions for mounting (height/width/depth) (mm)	600x560x550
Electric connection	AC 240 V
Nominal voltage of elements	240 V, 50 Hz
Max. temperature	250°C
Oven	
Temperature regulator/ function mode switch	1/1
Guide levels (telescopic guides in 3 levels-only certain models)	5
Top/bottom element (kW)	0,9/1,1
Grill element/ Grill element with fan (kW)	2,0/2,2
Oven illumination: top/side* (W)	25/25*
Function modes	
Top/bottom element (kW)	2,0
Top element (kW)	0,9
Bottom element (kW)	1,1
Grill element (kW)	2,0
Element adjacent to the fan (kW)	2,2
Fan motor adjacent to the element (W)	35
Turnspit motor* (W)	4
Cooling fan motor* (W)	11
Total connected power (kW)	3,4
Oven total (kW)	3,4

* depending on the equipment of the appliance

After sale service

Repairs

If your oven malfunctions and requires repair, contact our nearest service centre and quote the code and the type or model of the appliance.

Important!

Before contacting the service centre, check if you can repair the malfunction, using the instructions from the Troubleshooting guide section.

If the malfunction of the appliance was caused by the improper use, the service visit during the warranty period is not free of charge.

Save these instructions and keep them handy. If you sell the appliance, give the instructions to the new owner.

Rating plate

The rating plate is located at the bottom on the side when you open the oven door.

WE RESERVE THE RIGHT TO ALTER THE SPECIFICATIONS WITH NO INFLUENCE ON THE OPERATION OF THE APPLIANCE.

WARRANTY AND SERVICE

DOMESTIC WARRANTY - FULL FIVE YEAR WARRANTY

In addition to all statutory rights which you, the Consumer, have under the relevant laws in respect of this appliance, during the first five years of ownership as the original purchaser of this Kleenmaid appliance, we guarantee that any fault caused by faulty material or workmanship becoming apparent will be rectified free of charge for parts and labour, provided that all service is performed during normal working hours by Kleenmaid or their designated Agents. Where the appliance is installed outside the normal servicing area of the above, the Purchaser must pay for the cost of transporting the appliance to and from the Agent or the Agent's travelling cost to and from the Purchaser's home.

COMMERCIAL WARRANTY - ONE YEAR WARRANTY

When this appliance is installed in a commercial application, you, the Consumer, have under the relevant laws in respect of this appliance, during your first one year of ownership as the original purchaser of this Kleenmaid appliance, we guarantee that any fault caused by faulty material or workmanship becoming apparent, will be rectified free of charge for parts and labour, provided that all service is performed during normal working hours by Kleenmaid or their designated Agents. Where the appliance is installed outside the normal servicing area of the above, the Purchaser must pay for the cost of transporting the appliance to and from the Agent or the Agent's travelling cost to and from the Purchaser's home.

WHAT THESE WARRANTIES DO NOT COVER

We are not responsible for any damage or malfunction unless caused by a defect in material or workmanship. This includes but is not limited to abuse, misuse, improper installation and transportation damage. We are not responsible for any consequential damages from any malfunction.

The Consumer must make the appliance available for servicing and shall bear any costs incurred for any de-installation and/or re-installation required to make the appliance available for servicing. Kleenmaid is not liable for any consequential damage incurred during de-installation or re-installation.

WARRANTY DOES NOT COVER REPLACEMENT OF LIGHT GLOBES OR GLASS BREAKAGE DUE TO IMPACT

In case of fractured glass do not use your appliance.

WARRANTY REGISTRATION

Please complete warranty details below. Please retain together with your proof of purchase document. These documents will need to be viewed by our Service Representative should you request in warranty service.

SERVICE ASSISTANCE

To assist you when phoning our After Sales Service number to arrange a service call please complete the following details and have them ready when you call.

Model Number _____ Date of purchase _____

Kleenmaid Store purchased from _____ Date of installation _____

KLEENMAID AFTER SALES SERVICE
1300 652 100

**Other products available in the Kleenmaid
Range of appliances**

Washers

Dryers

Dishwashers

Ovens

Cooktops

Outdoor Cooking Centres

Built In Espresso Coffee Machines

Rangehoods

Freestanding Ranges

Sinks

Waste Disposals

Taps

Cookware

Refrigerators

Freezers

Wine Cellars

Vacuum Cleaners

**For sales information on the full range of quality appliances
Phone 13 13 08**

