

Electric Multi-Function Oven

MODELS: UEO1B/2B, DEO1B/2B
and UES-2B

Appliance Operation Manual

INCLUDING INSTALLATION AND CLEANING

WELCOME TO ST GEORGE

St George is a proud Australian company with a heritage of innovation and quality.

Our success extends to domestic and overseas markets, confirming our reputation at the forefront of appliance excellence.

The elegant simplicity and high performance features of St George designs, will remain contemporary in many years to come.

1. KNOWING YOUR St George ELECTRIC WALL OVEN	
1.1 Important Points	3
1.2 Installation Checks and Warnings	3
1.3 Features and Benefits	6
Accessories	5
2. USING THE APPLIANCE FOR THE FIRST TIME	
2.1 Power On	7
2.2 Burning In	7
3. CONTROL PANEL OPERATION	
Diagrams.....	9
3.1 One Handed Operation	8
3.2 Setting the Time of Day	8
3.3 Manual Operation	8
3.4 Changing the Alarm Tone	8
3.5 Using the Alarm Timer	10
3.6 Mode Switch	10
3.7 Oven Temperature Control	11
3.8 Grill Control	11
3.9 Roast Probe Operation	12
4. COOKING MODES AND INSTRUCTIONS	
4.1 Roasting Hints and General Guide	13
4.2 Preheating	16
4.3 Oven Cooking Modes Guide	17
4.4 Defrost	18
4.5 Normal Oven	19
4.6 Classic Bake (UEO DEO Models)	20
4.7 Fan Assist (UEO DEO Models)	20

AUSTRALIA
St. George Appliances
South Sydney Corporate Park
Letterbox No. 3
184 Bourke Road
Alexandria NSW 2015
Phone: 1300 652 100

NEW ZEALAND
The Applico Group Ltd
120 Captain Springs Road
Onehunga, Auckland
New Zealand
Phone: (09) 574 1050
Fax: (09) 574 1051

CANADA
Euro-Line Appliances
2150 Winston Park Drive
Oakville, Ontario L6H 5V1
Phone: (905) 829 3980
Fax: (905) 829 3985

Kleenmaid Pty Ltd

ACN 001 905 808

Trading As

St George Appliances

A Tradition of Excellence

5 Year Warranty
Proudly Australian Made

CONTENTS

4.8	Fan Oven	21
4.9	High Bake (UEO DEO Models)	22
4.10	Fan Grill.....	23
4.11	Grill.....	25
4.12	Normal Oven Cooking in Secondary Oven (DEO Models).....	26
4.13	Grilling in Lower Compartment (DEO Models).....	27
4.14	Roast Probe Cooking (UEO DEO Models)	28
4.15	Automatic Programmed Cooking	30
5.	CLEANING AND MAINTENANCE	
5.1	Recommended Cleaners	33
5.2	Routine Cleaning	35
5.3	Spills, Spatters and Accidents	36
5.4	Cleaning the Roast Probe	37
5.5	Removing Oven Door	38
5.6	Self Clean Oven Liners	39
5.7	Changing the Light Globe	39
5.8	Trouble Shooting Guide.....	40
6.	CABINET INSTALLATION INSTRUCTIONS	
6.1	Measurements	42
6.2	Preparing the Cupboard Cavity.....	42
6.3	Providing a Suitable Flue.....	46
6.4	Securing the Oven	46
7.	ELECTRICAL CONNECTION INSTRUCTIONS	
7.1	Wiring Rules and Warnings	48
7.2	Electrical Loads	48
7.3	Voltage Supply Connection	49

1. KNOWING YOUR ST GEORGE ELECTRIC WALL OVEN

1.1 Important Points

Thank you for purchasing a St George appliance that we are sure will provide many years of great cooking experiences. If you haven't had the pleasure of cooking with St George previously, you may find that it has different features and characteristics to your last appliance. It is essential you read this operation manual thoroughly to fully understand all of the various functions and operations. The aim is to encourage you to experiment with your cooking and take advantage of the features St George offers.

The versatility of your new appliance means most foods will cook successfully using alternative functions. The key to achieving results that best suit your personal taste is experimentation.

This manual should be retained for future reference. Should ownership of the appliance be transferred, please ensure that the manual is also passed onto the new owner.

1.2 Installation Checks and Warnings

In the interests of your safety and the care of your new appliance, please take time to carefully read this manual before installing and using the appliance. In particular your attention is drawn to the following: -

Incorrect installation of the appliance as a result of not following the detailed specifications can affect the appliances performance. Ovens incorrectly installed may invalidate the warranty and we strongly recommend that the oven cavity, venting and wiring be prepared as described in the specifications. This is critical to appearance, oven performance and safety. For installation details, please refer to **Cabinet Installation Instructions**.

A licensed electrician with relevant qualifications must perform electrical work when installing or servicing the appliance. The supply cable and fuse rating must be suitable for the appliance. You must never repair or replace any part of the appliance unless specifically recommended in the operation manual. For installation details, please refer to **Electrical Connection Instructions**.

VENTILATION SLOTS AND AIR VENTS MUST NOT BE COVERED OR OBSTRUCTED IN ANY WAY

DON'T USE ALUMINIUM FOIL ON THE BASE OF OVENS

The use of aluminium foil on the base of the oven to collect spills and improve cleaning is not recommended. The bottom element of St George ovens is concealed under the base of the oven liner (not exposed). Foil or dishes with reflective qualities must never be placed on the base of the oven during cooking as the concentration of the direct and reflected heat will damage the enamel surface. Damage resulting from such use is not covered under the provisions of the warranty. Refer to Cleaning and Maintenance for care instructions for your new appliance.

INITIAL HEAT UP

Some smoke and smell may be noticed during the initial heat up cycle (see **Using the Appliance for the First Time**). This should quickly dissipate. If abnormal levels of smoke are observed (i.e. it is not food that is burning) have the appliance thoroughly checked.

LEAVE SECONDARY OVEN DOOR OPEN DURING GRILLING

The oven door for the secondary oven (DEO models only) **MUST REMAIN FULLY OPEN** during grilling.

DON'T USE THE GRILL PAN HANDLE FOR LIFTING

The grill pan handle provided should only be used to assist in sliding the grill pan in and out of the oven compartments. **AT NO TIME MAY IT BE USED FOR LIFTING THE GRILL PAN, ESPECIALLY WHEN THE PAN IS LADEN WITH FOOD.**

DON'T USE THE APPLIANCE AS A SPACE HEATER

The appliance must never be used for warming or heating the surrounding room or for drying clothes or textiles or other items not specifically recommended in the operation manual. Combustible materials or products must never be placed on or near the appliance.

DO NOT LEAVE CHILDREN ALONE

Children must not be left unsupervised in the area where the appliance is in use. The appliance gets hot during use and retains heat for some time after being turned off. Children must never be allowed to sit or stand on any part of the appliance.

DO NOT SPRAY AEROSOLS IN THE VICINITY OF THE APPLIANCE WHILST IT IS IN OPERATION

OVEN CARE – ACIDIC FOODS

Certain foods can cause severe corrosion of enamel and metal finishes if the oven surface is not completely cleaned after use. This is particularly so around the joins in the oven liner and the chrome racks and shelves.

Examples of these are vinegar, sour milk, citrus fruits, olives, strong salt solutions and fruit juices. Regular inspection will alleviate the likelihood of this type of damage occurring. Some oven cleaners can also have a detrimental effect on vitreous enamel surfaces.

POLYUNSATURATED OILS

The excessive use of polyunsaturated oils in cooking can cause deposits of solidified oils on the inside surfaces of the oven and are extremely difficult to remove from glass and enamel finishes. Their use, where possible should be minimised.

AEROSOLS

DO NOT SPRAY AEROSOLS IN THE VICINITY OF THIS APPLIANCE WHILE IT IS IN OPERATION.

The use of aerosol cans such as insect spray, deodorants, repellents, stove cleaners, hair spray, paint and food preservatives etc., must be avoided in the proximity of your oven, especially near controls or switches. Some aerosols contain chemicals that cause rapid corrosion of metals and enamels. This normally shows in the form of white staining of the vitreous enamel or rusting. Damage of this kind is not covered in the appliance warranty.

OVEN CLEANERS

We recommend a non-caustic oven cleaner be used at all times. Any residue of oven cleaner should be thoroughly removed to avoid corrosion of metal finishes.

- **NEVER** use the oven to dry out oven cleaners as they can produce a highly corrosive chemical reaction that will attack the enamel.

- **NEVER** activate any element or burner on the appliance (except oven light) while there is oven cleaner in the oven compartment.

WEAR PROPER APPAREL WHEN USING THE APPLIANCE

Loose fitting, hanging or highly flammable garments (such as synthetics) should never be worn while using the appliance.

USE ONLY DRY POT HOLDERS

Moist or damp pot holders on hot surfaces may result in burns from steam. Do not allow pot holders to touch hot heating elements. Do not use a towel or bulky cloth when handling hot cooking utensils used in the appliance.

DON'T USE OVEN OR GRILL COMPARTMENTS FOR STORAGE

Items, particularly flammable materials, must never be stored in an oven or near surface units.

DO NOT USE WATER ON GREASE FIRES

Fats, oils or other substances will ignite if they become too hot. Fires or flames should be smothered using flameproof material or extinguished using a dry chemical or another suitable fire retardant.

USE AUTOMATIC PROGRAMMED COOKING ONLY IN SUITABLE MODES

Automatic programmed cooking is available in the main oven only and suitable only in the following modes (where applicable):
- *Normal Oven, Classic Bake, Fan Assist, Fan Oven, High Bake and Fan Grill* modes.

ONLY PLACE COOKWARE ON OVEN SHELVES

Other surfaces of the appliance, for example trims, are not totally resistant to hard or sharp materials or direct heat and may be damaged by such use.

Accessories Shelf Levels

(The 6 shelf levels assure the optimal use of the 92 litre oven)

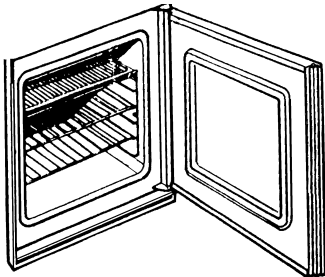

Grill & Pan Rack

(Acts as an extra shelf and the pan is coated with vitreous enamel for long life and easy cleaning)

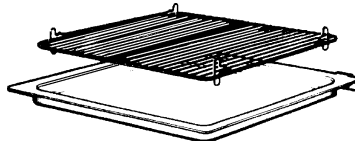

Self Clean Oven Liners

Optional Extra — great to alleviate extra cleaning requirements).

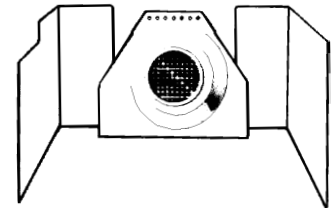

1.3 Features and Benefits

A range of cooking options is combined in your St George wall oven. St George's extra large ovens allow you to cook everything from small simple dishes for one, to complete dinners for the whole family. The multi-function modes available in the main oven (up to 9) give you the ability to defrost food, bake either conventional or fan-forced, with a high bake option (JEO and DEO models only) for pastry foods, as well as conventional grilling or fan grilling for excellent rotisserie style flavour.

The lower compartment of the DEO models offer a variable heat grilling facility. The secondary ovens (DEO only) also offer conventional oven cooking. This allows you to cook smaller meals, bake entrees or desserts, or grill separately while cooking a meal in the main oven.

The control panel features a 24-hour electronic clock that incorporates an independent timer, useful for timing household activities. The electronic oven controller allows manual operation or the ability to program cooking times, giving you the freedom to cook meals to suit your own schedules.

NOTE: Automatic programmed cooking operates in the main oven only.

Cleaning the oven interior is made simple with St George's high quality vitreous enamel. For easy access the oven doors either fully open (side opening) or easily lift off and the in-oven parts are removable. (refer to **Cleaning and Maintenance** for complete care instructions)

If over heating occurs, however unlikely, there are safety systems that re-set or shut down the unit.

2. USING THE APPLIANCE FOR THE FIRST TIME

After installation remove all notification labels (not grill or electrical warning labels), advertising, tape, packaging, etc. A quick diluted wash with Ammonia and water should rinse away any adhesive residue. Eucalyptus oil (small amounts) is also good for removing adhesive residue. Thoroughly rinse cleaned surfaces and wipe them dry using a clean, soft cloth.

NOTE: People with sensitivity to cleaning chemicals must take the necessary precautions. St George recommends wearing protective gloves while cleaning the appliance.

2.1 Power On

The time of day is displayed in digital 24-hour format (e.g. 18:00 is 6:00 p.m.). When power is first applied the time of day (**0:00**) and **AUTO** flashes in the display.

Pressing the Reset button cancels power-up mode and automatically places the unit in manual mode.

2.2 Burning In

Before cooking in the appliance an initial pre-heat is required to burn off the fine oil film used to protect the elements during shipping. The first time you heat up the oven (or grill) the oil will be given off as smoke (some smell may also be noticeable), which is perfectly normal.

1. Set the oven for manual operation by pressing the *Reset* button.
2. Select *Fan Oven* on the mode switch and set the main oven temperature to 180°C.
3. With the oven door closed, leave the oven on for approximately 1 hour or until the smoke has disappeared.
4. Change the selection on the mode switch to *Fan Grill* and leave for a further 20 minutes or until the smoke has disappeared.
5. For the DEO models, with the secondary oven door open, set the grill control to it's maximum setting and leave on for at least 20 minutes or until the smoke has disappeared.

After completing the above turn the oven/s off. The oven/s are now ready for cooking and grilling.

NOTE: The secondary oven (DEO models) may be burned in at the same time as the main oven.

CONTROL PANEL OPERATION

3. CONTROL PANEL OPERATION

3.1 One Handed Operation

The oven timer control has been designed so that it requires only one hand to operate any of its various functions. To alter any of the functions or settings you need only to press the relevant button/s. The selected function will remain active for a few moments allowing you to adjust the setting. The \vee or \wedge buttons can be pressed to adjust the displayed time.

When the \vee or \wedge buttons are pressed singularly the time will change in 1 minute steps. If the \vee or \wedge buttons are held down the time will change more rapidly.

When you are finished the selection will be set and the display will revert to the time of day.

NOTE: The **AUTO** symbol may flash and/or the  symbol may be displayed if those functions have been inadvertently set. To cancel any **AUTO** settings press the *Reset* button. To cancel the timer function, press the *Timer* button and set the alarm time back to zero. If an alarm sounds, pressing any of the 4 left hand buttons will cancel it.

3.2 Setting the Time of Day

The time of day can be set at any time by pressing the *Reset* button. Once pressed the time can then be set by pressing the \vee or \wedge buttons. The unit will then commence timing from the selected time on the display.

NOTE: If the unit is in automatic mode, resetting the time of day will cancel any automatic settings.

3.3 Manual Operation

Pressing the *Reset* button at any time after turning power on (see 2.1 above) will cancel any automatic setting in memory and allow the unit to be used manually. The  indicator will be displayed to show manual operation has been set.

3.4 Changing the Alarm Tone

The alarm tone can be changed to either one of 3 selections. Simply press the \vee button singularly to cycle through the available selections.

NOTE: This only works if no other function is active when the \vee button is pressed.

DEO

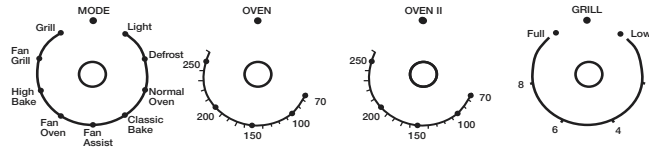
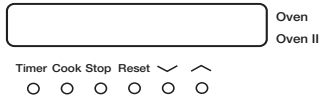

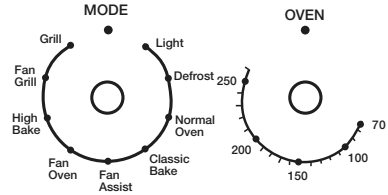
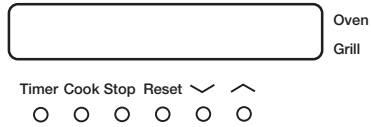

UEO



3.5 Using the Alarm Timer

The alarm timer can be used independently of other clock functions. Very handy for letting you know when to turn food, when basting is required or when a batch of food (when cooking multiple batches) is ready without interrupting the oven operation. The alarm timer is also very useful for timing other household activities.

To set the alarm timer press the *Timer* button to display the time remaining until the alarm sounds. The alarm time can then be set by pressing the \vee or \wedge buttons. The  symbol will be displayed to show an alarm time has been set. When you are finished selecting an alarm time the display will revert back to the time of day. The remaining time to the alarm can be displayed momentarily and altered using the *Timer* and \vee/\wedge buttons. To cancel the alarm timer simply reset the alarm time to zero. The  symbol will no longer show and the display will revert back to the time of day.

Once the alarm time has elapsed the alarm will sound. Pressing any of the four left-hand buttons will cancel the alarm and the  indicator will no longer be displayed. If not manually cancelled the alarm will automatically cancel after a few minutes.

NOTE: Whilst the alarm time is displayed pressing the \vee or \wedge buttons will change the alarm time setting.

If the *Reset* button is pressed to cancel any alarms, any automatic settings in memory will be cancelled and the unit will return to manual operation.

3.6 Mode Switch

This switch selects the mode of cooking you require and may be turned in either direction to give you the following selections:

UEO DEO Models

<i>Light</i>	<i>Defrost</i>
<i>Normal Oven</i> (conventional oven)	
<i>Classic Bake</i>	<i>Fan Assist</i>
<i>Fan Oven</i>	<i>High Bake</i>
<i>Fan Grill</i>	<i>Grill</i>

The *Light* selection is included to assist when cleaning the oven interior. The oven illumination lamp will remain on at all times on any selection except off. This provides an extra safety precaution to indicate that the oven has been left on.

3.7 **Oven Temperature Control**

This control allows you to select the temperature to be maintained during cooking. Turn the control clockwise to switch power on and select your required temperature. An indicator light will show when the oven is heating and will cycle on and off as the temperature is maintained. The indicator light will operate this way when any oven mode with temperature control is used (i.e. *Fan Oven, Normal Oven, Classic Bake, Fan Assist, High Bake or Fan Grill*).

The control can only be turned anti-clockwise to the off position.

NOTE: For DEO models the secondary oven thermostat overrides the grill control if both controls are on at the same time.

3.8 **Grill Control**

Grilling in the oven is controlled by setting the mode switch to *Grill*. The speed of cooking may be varied by altering the grill pan and rack positions.

The separate grill control (DEO Models) is used to select the heat desired for grilling in the lower compartment only. The control may be turned in either direction.

NOTE: For DEO models the secondary oven thermostat overrides the grill control if both controls are on at the same time.

3.9 Roast Probe Operation

WARNING: This mode of cooking is suitable only for *Normal Oven*, *Classic Bake*, *Fan Assist*, *Fan Oven* or *High Bake* modes. Use of the probe sensor in either *Grill* or *Fan Grill* modes will damage the probe.

The roast probe operation shares the same digit display as does the timer functions and operates only in the main oven. The roast probe must be plugged into its socket within the oven compartment to display the current temperature of the roast probe sensor in the left-hand pair of digits. The Roast Probe Set Temperature (RPST) will be displayed in the right hand pair of digits and can be adjusted by pressing the \vee or \wedge buttons.

NOTE: The RPST can be set between 0°C and 99°C, however, it is not recommended to set the RPST above 85°C as this gives inconsistent results and may result in the burning of food.

Once the temperature of the roast probe's sensor reaches or exceeds the RPST the oven will automatically turn off and the alarm will sound. The alarm can be cancelled by pressing any of the 4 left-hand buttons. If not manually cancelled the alarm will self cancel after a few minutes. To cancel the roast probe function, remove the roast probe from its socket.

For complete details refer to **Roast Probe Cooking**.

NOTE: Whenever the roast probe is plugged in, the RPST is re-set to 80°C.

The time is not displayed when the roast probe is plugged in. If the roast probe is disconnected the display reverts back to the time of day.

Automatic programmed cooking can be used with the roast probe.

4. COOKING MODES AND INSTRUCTIONS

4.1 Roasting Hints and General Guide

When roasting or baking, position food near the centre of the oven. This will vary on the size of the food to be cooked or if other foods are to be cooked at the same time. Cooking times may vary slightly depending on, for example, the size and thickness of meat or the presence of bone or stuffing.

The temperature for roasting meats and poultry will usually range between 170°C and 200°C. These temperatures will normally prevent excessive shrinkage and moisture loss. An exception is roast pork which is placed in a hot oven (around 220°C to 230°C) for the first 15-25 minutes to obtain a crisp crackling, after which the temperature is reduced to 180°C to 200°C for the remaining cooking time. Of course these temperatures and times will vary according to your own personal taste.

Bake meat and vegetables in baking dishes that allow the heat to circulate evenly and brown the food to your own taste. When cooking more than one dish of food at the same time place the cooking utensils so that they do not touch each other or the sides of the oven. To allow free circulation of heat, do not arrange pans directly above each other, stagger their positions if possible.

When using the oven to bake a complete meal at one time, for example meat, vegetables and dessert, place the meat in the lower part of the oven and place the vegetables and dessert above. Note that the cooking times and temperatures when cooking this way should be similar for each of the dishes. The oven temperature may also need to be increased slightly to account for the larger volume of food being cooked. Please note that not all types of food are suitable for cooking together. (e.g. some desserts are not suitable to be cooked with meat)

Make use of retained heat whenever possible. For example, after baking a dinner there should be sufficient retained heat to dry herbs, breadcrumbs and biscuits or fruit.

COOKING MODES AND INSTRUCTIONS

OVEN TEMPERATURE °C	GENERAL TIMES	FOODS SUITABLE
130° and under	Very Slow	small meringues, pavlova, baked custard, re-heating
130° – 150°	Slow	rich fruit cake light fruit cake
150° – 180°	Moderate	casseroles deep butter cakes
180° – 200°	Moderately Hot	shallow butter cakes, sponges biscuits, meat loaf, baked fish
200° – 230°	Hot	swiss roll, patty cakes rock cakes, shortcrust pastry
230° and over	Very Hot	scones, choux pastry

*These Cooking Charts are intended as a guide only.
Temperatures and cooking times may be varied to suit individual tastes.*

TEMPERATURE GUIDE
APPROXIMATE ROASTING TIMES FOR MEAT, POULTRY & FISH

TYPE OF MEAT	CUTS OF MEAT	TIME/KG	OVEN TEMPERATURE °C
BEEF	Standing Rib, Rolled Sirloin Bolar Blade, Corned Topside	60 mins per kg	180°–200°
	Fillet, Scotch fillet	40 mins per kg	180°–200°
VEAL	Shoulder or leg (with bone or rolled)	40-50 mins per kg	180°–200°
LAMB	Leg, Shoulder (loin or rolled)	40-50 mins per kg	180°–200°
PORK	Leg Loin	90 mins per kg	220°–230°/180°–200°
*Pork Legs should be cooked at higher temperature for first 15-25 minutes then reduced to lower temperature for remaining cooking time.			
TYPE OF POULTRY/FISH	CUTS/SIZE	TIME/500g	OVEN TEMPERATURE °C
CHICKEN	Whole or Pieces	30 mins per 500g	180°–200°
DUCK	1.4 - 1.9kg	30 mins per 500g + 35 mins extra	180°–200°
TURKEY*	2.5 - 10.0kg	30 mins per 500g + 35 mins extra	180°–200°
*Turkeys should be well basted and turned during cooking.			
FISH*	Whole or Fillets	10 mins per 500g	170°–190°
*In <i>Normal Oven</i> mode, fish should be covered for the first 3/4 of the cooking time to help retain moisture			

*These Cooking Charts are intended as a guide only.
 Temperatures and cooking times may be varied to suit individual tastes.*

4.2 Preheating

Preheating the oven is not essential, but you will achieve better results if you do. Some foods, particularly cakes and pastry, are better cooked in a preheated oven. Other foods, for example casseroles, cook just as well when cooked in a non-preheated oven but may need longer cooking times.

To preheat the main oven:

1. Set the mode required for preheating.
2. Set the oven to the desired temperature.

PREHEATING GUIDE (for 180°C setting)	
Cooking Mode	Preheat time (mins)
<i>Normal Oven</i>	25-30
<i>Fan Oven</i>	15-20
<i>High Bake</i>	8-12

For your cooking convenience use *Fan Oven* or *High Bake* modes for fast, efficient preheating of the main oven.

Please note that any food or other cooking utensils placed in the oven during preheating will affect the preheating time. The preheat time may also vary with installations.

WARNING: When using an alternative cooking mode for faster preheat, be sure to turn the cooking mode to your required setting before placing food in the oven.

HINT: To allow for heat loss while placing food into the oven, preheat the oven 10-20°C higher and then reduce the temperature to your required cooking temperature.

Always preheat the oven when cooking multiple dishes at the same time.

To preheat the secondary oven (DEO Models)

1. Set the oven to the desired temperature. The oven will preheat to 180°C in 15-20 minutes.

COOKING MODES AND INSTRUCTIONS

4.3 *Oven Cooking Modes Guide*

Oven Mode Main Oven	Elements	Mode Descriptions	Cooking Suggestions
Defrost	Only the Fan operates	This mode offers a clean and healthy way to defrost frozen foods	All foods may be defrosted using this mode
Normal Oven	Concealed bottom element and top outer element	Single item cooking. Foods that require long slow cooking	Fruit Cakes, Christmas Cakes, Meringues, Breads, Crème Caramels, Custards, Soufflés
Classic Bake	Concealed bottom element	Blind baking	Pastry cases, Quiche bases
Fan Assist	Concealed bottom element, top outer element and Fan	Used for multi-shelf purposes	Versatile in batch cooking, where one dish must have a well cooked base and another must be well browned
Fan Oven (Fan Forced)	Fan element and Fan	Multi-shelf cooking Multi-purpose general cooking	Cakes, Biscuits, Puddings, Baking whole Fish, Roast meat and vegetables
High Bake	Concealed bottom element, Fan element and Fan	Foods that require a high heat and a crisp base	Pizza's, Quiches, Pies and Scones
Fan Grill (Oven door remains closed on this mode)	Grill element and Fan	Ideal for grilling all meats and vegetables – the grill tray should be placed in the middle of the oven with the wire rack elevated	Roasts, Steak, Chops, Meatballs, Hamburger patties
Grill (in main oven) (Oven door remains closed on this mode)	Grill element	Straight quick grilling	Toasted cheese sandwiches. Browning food

DEO only

Oven Mode Secondary Oven	Benefit
Normal Oven	In this mode the outside ring of the top element and the concealed bottom element provide the oven heat. Normal oven is most suitable when cooking on one rack only. For best results, arrange the shelves so that the top of the food is in the centre of the oven.
Grilling in lower compartment. (Door must be fully open in this mode)	This mode of cooking uses the heat of the top inner element to cook food to your requirements. Door must be fully open.

4.4 **Defrost**

The *Defrost* mode offers a clean and healthy means to defrost frozen food. Food left in the open is exposed to contamination by pets and insects. With the *Defrost* setting, food placed in the oven defrosts without heat, reducing the likelihood of growing bacteria. The circulation of air in the oven achieves effective thawing. The oven does not provide any heat on this setting which prevents food extremities from over-thawing, or even cooking, like they tend to do in a microwave.

All foods may be defrosted using this method but it is especially good for meat and fish fillets and delicate frozen foods such as cream cheesecakes or cakes with cream filling, icing or frosting. The time taken to defrost foods will vary, depending on the volume and weight of the food. As a general guide the defrosting time for meat should be approximately 15-20 minutes per kg.

Using *Defrost* Mode

1. Adjust oven shelves to correct position (this mode is most effective when food is placed near the centre of the oven).
2. Select *Defrost* on the mode switch.
3. When defrosting is complete, turn the oven off.

NOTE: A temperature cannot be set when *Defrost* mode is selected.

To prevent spoilage of food, do not use *Defrost* for longer than necessary (periodically check food during defrosting). If food is not to be cooked immediately when defrosting is complete, remove the food from the oven and place into a refrigerator until needed.

4.5 **Normal Oven**

In this mode the outside ring of the top oven element and a concealed element under the oven compartment provides the oven heat. *Normal Oven* is most suitable when cooking on one rack only. For best results, arrange the shelves so the top of the food is near the centre of the oven. This is usually the second or third shelf position from the bottom. If cooking on more than one shelf, always preheat the oven and stagger the positions of baking trays to allow free circulation of heat within the oven. Depending on the food, you may need to rearrange tray positions during cooking.

Using Normal Oven Mode

1. Adjust oven shelves to desired position/s.
2. Select *Normal Oven* on mode switch.
3. Set the oven to the desired temperature.
4. When cooking is complete turn the mode switch and thermostat off.

HINT: If water is used in your cooking (such as water placed in a baking dish) the water evaporating during cooking may cause condensation to escape and run down the front of your appliance. This should not cause any problem to your appliance, however it is advisable to wipe away the condensation from the exterior of the oven with a very warm damp cloth during cooking. The level of condensation will be reduced when cooking in *Fan Oven* mode where excess moisture is circulated and evaporates during the cooking cycle.

NOTE: Always stand clear of the oven when opening the oven door/s as built up steam may escape rapidly.

4.6 **Classic Bake**

On the *Classic Bake* selection, heat is provided only by the concealed element under the oven compartment. This mode is ideal where food must have a well-cooked base or where minimal browning is desired.

Using Classic Bake Mode

1. Adjust oven shelves to desired position/s.
2. Select *Classic Bake* on mode switch.
3. Set the oven to the desired temperature.
4. When cooking is complete turn the mode switch and thermostat off.

4.7 **Fan Assist**

In *Fan Assist* mode, heat is provided by the outside ring of the top oven element and the concealed element under the oven compartment in conjunction with the oven fan. *Fan Assist* is versatile in batch cooking (where even temperature is essential), where one dish must have a well-cooked base and another must be well browned.

Using Fan Assist Mode

1. Adjust oven shelves to desired position/s.
2. Select *Fan Assist* on mode switch.
3. Set the oven to the desired temperature.
4. When cooking is complete turn the mode switch and thermostat off.

HINT: Always preheat the oven when cooking multiple dishes at the same time.

4.8 **Fan Oven**

In this mode the oven fan circulates heat from an element concealed behind the fan cover to give more even temperature throughout the oven. When cooking more than one tray of food on multiple shelves the even heat provides similar cooking results throughout each portion of food. Temperatures for cooking foods in this oven mode are generally the same as required by a conventional oven, however, when cooking foods that require lengthy cooking cycles a fan forced oven normally cooks more quickly, saving both time and energy (e.g. rich fruit cakes and large roasts).

Always place the food as near to the centre of the oven as possible. If cooking on more than one level, stagger the positioning to allow for as much free circulation of heat within the oven as possible.

Using Fan Oven Mode

1. Adjust oven shelves to desired position/s.
2. Select *Fan Oven* on mode switch.
3. Set the oven to the desired temperature.
4. When cooking is complete turn the mode switch and thermostat off.

HINT: Always preheat the oven when cooking multiple dishes at the same time. Depending on the food, you may need to rearrange the tray positions during cooking.

After cooking is complete the oven will retain heat for a period of time after being turned off. The retained heat can be used to dry foods or to keep food warm prior to serving. Examples of foods that may be dried are breadcrumbs, herbs or fruit. To prevent heat loss when using the oven in this way do not leave the oven door open or open the door too often. Also remember to remove food from the oven to prevent spoilage.

4.9 **High Bake**

The *High Bake* mode uses the concealed elements behind the fan cover and under the oven in combination. With the addition of the forced convection of the oven fan, quick and consistent heat is evenly distributed throughout the oven. *High Bake* has the advantage of excellent cooking results for pastry foods such as hors d'oeuvres and especially Pizza.

The results are quick, not unlike a microwave oven. With the circulation of heat, foods cooked with *High Bake* mode retain a crisp, dry texture on the outside. Especially Pizza, pastry and other foods where you want the base to be well cooked. *High Bake* is also excellent for re-heating.

Using High Bake Mode

1. Adjust oven shelves to desired position/s.
2. Select *High Bake* on mode switch.
3. Set the oven to the desired temperature.
4. When cooking is complete turn the mode switch and thermostat off.

4.10 **Fan Grill**

Fan grilling is a combination of direct heat and circulated hot air which gives the appearance and flavour similar to rotisserie cooking – a crunchy exterior with succulent meat – which is ideal for single level roasts. In this mode the direct infrared heat from the grill element is also circulated by the fan to cook the food. Note that the food should be positioned as near to the centre of the oven as possible.

With the added benefit of the circulated air, more even cooking can be achieved giving excellent results. The *Fan Grill* mode has been developed to replace grilling with the door open and has the following advantages over conventional grilling:–

1. Food is generally more moist.
2. Improved rotisserie style flavour.
3. Most cooking fumes from grilling pass through the oven vent.
4. Reduced spatter when cooking fatty meats.

For even browning, St George recommends turning food once only.

Using Fan Grill Mode

1. OVEN DOOR MUST BE CLOSED IN *Fan Grill* MODE
2. Place food on grill rack and pan supplied (ensure grill rack is inverted to the high position to allow best circulation of air).
3. Place grill pan on shelf carrier so that the food is positioned as close as possible to the centre of the oven.
4. Select *Fan Grill* on mode switch.
5. Set the oven to the desired temperature. (see Note below and refer to **Fan Grill Temperature Guide**)
6. When cooking is complete turn the mode switch and thermostat off.

NOTE: Large grill pans or roasting dishes can restrict the circulation of air in the oven. To prevent moisture condensing in the cooler lower sections of the oven, preheat the oven for approximately 10 minutes using *Normal Oven* or *High Bake* modes prior to fan grilling.

NOTE: The temperature setting in *Fan Grill* mode must not exceed 200°C (390°F).

The grill element has a safety shutdown at approximately 200°C (390°F). Once the temperature in the oven has reached this limit the element will be switched off. The element will switch back on once oven cools slightly.

WARNING: The grill pan handle provided should only be used to assist in sliding the grill pan in and out of the oven compartments. **AT NO TIME MAY IT BE USED FOR LIFTING THE GRILL PAN, ESPECIALLY WHEN THE PAN IS LADEN WITH FOOD.**

***Fan Grill* TEMPERATURE GUIDE**

TYPE OF MEAT/POULTRY/FISH		OVEN TEMPERATURE °C	APPROXIMATE COOKING TIME
Chicken	Whole Pieces	175–185 185–195	30 mins per 500g 15-20 mins
Lamb	Loin/Rack Chops, medium/rare Chops, medium	175–185 175–185 175–185	25 mins per 500g 10-12 mins 14–16 mins
Beef	Steak, rare Steak, medium Steak, well-done	175–185 175–185 175–185	6-8 mins 10–12 mins 12-15 mins
Pork	Chops, medium/rare Chops, medium Chops, well-done	190–200 175–185 175–185	6-10 mins 10-12 mins 12–15 mins
Bacon		190-200	5-6 mins
Sausages	Thin Thick	175–185 175–185	8–10 mins 12-14 mins
Fish	Fillets, rolled Fillets, thick Whole	175–185 175–185 190–200	10–12 mins 10–12 mins 15-30 mins
Sliced vegetables		180-190	20-30 mins
Tomato halves		190–200	6–8 mins
Sauce-based recipes with breadcrumb toppings		175–185	20-30 mins
Pasta dishes		175–185	20-30 mins

*These Cooking Charts are intended as a guide only.
Temperatures and cooking times may be varied to suit individual tastes.*

4.11 **Grill (in main oven)**

This mode of cooking uses the infrared heat of the top inner element to cook foods to your requirements. The cooking can be varied by lowering or raising the grill pan and rack position in the oven. For the DEO models, this oven grilling facility is additional to the grill in the lower compartment.

This method of grilling in the oven is recommended for short duration (5 minutes or less) grilling ONLY which is ideal for toasting (see note below). **Foods with higher fat content or foods that require more than 5 minutes grilling time must be grilled using the Fan Grill mode.** The *Fan Grill* mode has been developed to generally replace grilling with the door open (see **Fan Grill** for details on *Fan Grill* mode).

When in Grill mode the oven door should be closed. If the door is not closed, discoloration may occur to the control panel. IT IS RECOMMENDED THAT THE MAIN OVEN *Grill* MODE IS NOT OPERATED WHEN RESIDUAL HEAT REMAINS IN THE OVEN.

Using Main Oven Grill Mode

1. Commence grilling from a cold oven only.
2. Place food on grill rack and pan supplied (use grill rack in low position).
3. Place grill pan on shelf carrier position of your preference.
4. Select *Grill* on mode switch.
5. For the UEO and DEO models, the oven has a pre-set temperature for the *Grill* mode.
The oven and grill controls cannot override this pre-set temperature.
6. When cooking is complete:-
For the UEO and DEO models turn the mode switch to the off position.

NOTE: The grill element has a safety shutdown at approximately 200°C. Once the temperature in the oven has reached this limit the element will be switched off. The element will switch back on once the oven cools slightly. (This temperature is generally reached after approximately 10 minutes)

WARNING: The grill pan handle provided should only be used to assist in sliding the grill pan in and out of the oven compartments. **AT NO TIME MAY IT BE USED FOR LIFTING THE GRILL PAN, ESPECIALLY WHEN THE PAN IS LADEN WITH FOOD.**

4.12 Normal Oven Cooking in Secondary Oven (DEO Models)

In this mode the outside ring of the top oven element and a concealed element under the oven compartment provides the oven heat. The secondary oven is most suited to cooking on one rack only. For best results, arrange the shelves so the top of the food is near the centre of the oven. This is usually the first or second shelf position from the bottom. If cooking more than one dish, always preheat the oven and stagger tray positions to allow free circulation of heat within the oven. Depending on the food, you may need to rearrange tray positions during cooking.

Using Normal Oven Mode in the Secondary Oven

1. Adjust oven shelves to desired position/s.
2. Set the oven to the desired temperature.
3. When cooking is complete turn the thermostat off.

HINT: If water is used in your cooking (such as water placed in a baking dish) the water evaporating during cooking may cause condensation to escape and run down the front of your appliance. This should not cause any problem to your appliance, however it is advisable to wipe away the condensation from the exterior of the oven with a very warm damp cloth during cooking.

NOTE: Always stand clear of the oven when opening the oven door/s as built up steam may escape rapidly.

4.13 Grilling in Lower Compartment (DEO Models)

This mode of cooking uses the infrared heat of the top inner element to cook foods to your requirements.

Using the Grill in Lower Compartment

1. DOOR MUST BE FULLY OPEN AT ALL TIMES DURING GRILLING.
2. Place food on grill pan and rack supplied (use grill rack in either low or high position to your preference).
3. Place grill pan on shelf carrier.
4. Select the heat desired for grilling using the *Grill* control.
5. When cooking is complete, turn the *Grill* control to the off position.

NOTE: The grill control of the DEO models operates independently of the mode switch and must be in the off position for the grill to be off. The secondary oven thermostat overrides the grill control if both controls are on at the same time.

WARNING: The grill pan handle provided should only be used to assist in sliding the grill pan in and out of the oven compartments. **AT NO TIME MAY IT BE USED FOR LIFTING THE GRILL PAN, ESPECIALLY WHEN THE PAN IS LADEN WITH FOOD.**

4.14 Roast Probe Cooking

The roast probe allows precise cooking results and is ideal for the novice or gourmet cook alike. The main oven provides the facility to sense the temperature of a meat joint when roasting. The sensor probe, manufactured from stainless steel, is inserted into the fleshiest part of a meat joint and plugged into the socket (located near the oven lamp) in the oven compartment. The oven automatically turns off when the temperature of the meat joint reaches your selected roast probe set temperature providing a carefree and simple method of cooking roasts.

The tip of the probe must be placed into the fleshiest part of the meat joint to accurately sense the meat temperature. The probe should not be allowed to touch or rest against bone or fat as these will reach different temperatures than the flesh of the meat and may give inaccurate results. When cooking loin or leg roasts, insert the probe from the round bone end. If cooking thin or small roasts, insert the probe at an angle so that the meat supports it, with the tip in the centre of the meat. Do not remove the probe from the meat until the cooking process is complete. The read-out on the display will show the meat temperature during cooking. The alarm will sound and the oven will automatically turn off when the meat has reached the temperature you have set.

Cooking Using the Roast Probe

1. Adjust oven shelves to desired position/s.
2. Insert the probe into the fleshiest part of the meat and place the meat joint into the oven. Plug the probe into the socket located in the oven.
3. The current probe temperature will be displayed in the left-hand pair of digits and the right hand pair of digits will display 80°C. (If necessary, refer to **Roast Probe Operation** for complete details)
4. Set the required temperature for the meat to reach when cooked (i.e. the Roast Probe Set Temperature, RPST) by pressing the \vee or \wedge buttons. Refer to the **Roast Probe Temperature Chart** for guidance.
5. Set the oven to the desired temperature.
6. When the temperature of the probe reaches the RPST the alarm will sound and the oven will automatically turn off.
7. If cooking is complete cancel the alarm, remove the probe from its socket and turn all controls off.

NOTE: The maximum recommended RPST is 85°C. Setting the RPST above 85°C gives inconsistent results and may result in the burning of food.

When not being used, remove the roast probe, clean (refer to **Cleaning the Roast Probe**) and store in a convenient location.

ROAST PROBE TEMPERATURE CHART

TYPE OF MEAT	APPROXIMATE COOKING TIME	OVEN TEMPERATURE °C	ROAST PROBE SET TEMPERATURE °C	TENDERNESS
Beef	60 minutes per kg	170–200	60–65 65–75 75–85	Rare Medium Well-done
Lamb	60 minutes per kg	170–200	65–75 75–85	Medium Well-done
Hogget	70 minutes per kg	170–200	75–85	Well-done
Pork	90 minutes per kg	170–200	80–85	Well-done
Veal	90 minutes per kg	170–200	65–75	Well-done
Whole Chicken	90 minutes per kg	170–200	75–85	Well-done

Note: These cooking times and temperatures are recommended using the *Fan Oven* mode.
Pork and Veal should normally be well done.

*These Cooking Charts are intended as a guide only.
Temperatures and cooking times may be varied to suit individual tastes.*

4.15 Automatic Programmed Cooking

The main oven can be set to turn on and off automatically. Using automatic settings normally implies that food will be left unattended in the oven. It is important to select food that:-

- does not have to be supervised during cooking;
- will last safely for possibly long periods in the oven prior to cooking;
- will last safely in the oven after cooking is complete.

When calculating cooking times, remember to take into account the retained heat after the oven turns off (particularly if the oven will be unattended when it turns off) and (if applicable) any pre-heating time.

NOTE: Automatic cooking is available in the main oven only and suitable only in *Normal Oven*, *Classic Bake*, *Fan Assist*, *Fan Oven*, *High Bake*, and *Fan Grill* modes.

Once the oven is programmed:-

The remaining cooking and finish times can be momentarily displayed and altered by using the *Start/Cook*, *Stop* and $\vee \wedge$ buttons.

To cancel the automatic settings press the *Reset* button. The settings will be erased and the **AUTO** symbol will no longer be displayed.

NOTE: If the times are set or altered such that the finish time is less than the present time plus the cooking time an alarm will sound. Check the set times and correct them or press the *Reset* button to erase the settings then re-enter the appropriate automatic settings.

If the *Reset* button is pressed to cancel any alarms, any automatic settings in memory will be cancelled and the unit will be set for manual operation.

4.15.1 Setting the Oven to Stop Automatically

This function is used to start cooking immediately and cook for a selected length of time or until a selected time of day.

To set a cooking duration time (i.e. cook for a selected length of time) press the *Start/Cook* button to display the remaining cooking time. The cooking time can be set using the \vee or \wedge buttons.

OR

To set a finish time (i.e. cook until a selected time of day) press the *Stop* button to display the current finish time. The finish time can then be set using the \vee or \wedge buttons.

The **AUTO** and  symbols will be displayed to show a program has been set and the display will revert to the time of day. Select the mode of cooking and the temperature you require. The oven will commence operation immediately and will cook for the selected cooking duration time or until the selected finish time.

Once the program is complete the oven will automatically turn off and the alarm will sound. The **AUTO** indicator will flash and the  symbol will no longer be displayed. Pressing any of the 4 left-hand buttons will cancel the alarm. If not manually cancelled the alarm will self cancel after a few minutes.

Remember to ensure all oven controls are OFF if no further cooking is required.

4.15.2 Setting Oven to Start and Stop Automatically

This mode is used to cook for a selected length of time and finish cooking at a selected time. The cooking time and the finish time can be programmed in any order, however, in the following description the cooking time is set first.

To set the cooking time press the *Start/Cook* button to display the remaining cooking time. The cooking time can then be set using the \vee or \wedge buttons. The **AUTO** and  symbols will be displayed to show a program has been set and the display will revert to the time of day.

To set the finish time, press the *Stop* button to display the current finish time (i.e. the current time of day plus the set cooking time). The finish time can then be set using the \vee or \wedge buttons. If a delayed start has been set, the time of day and the **AUTO** symbol will be displayed.

Select the mode of cooking and the temperature you require. The electronic timer will calculate the difference between the set finishing time and the selected cooking time to achieve the correct time that the oven will commence operation. The oven will turn on at the calculated time, the  symbol will be displayed and the oven will cook until the selected finish time.

Once the finish time is reached the oven will automatically turn off and the alarm will sound. The AUTO indicator will flash and the  symbol will no longer be displayed. Pressing any of the 4 left-hand buttons will cancel the alarm. If not manually cancelled the alarm will self cancel after a few minutes

Remember to ensure all oven controls are OFF if no further cooking is required.

5. **CLEANING AND MAINTENANCE**

Proper cleaning and maintenance of your appliance will provide you with years of pleasant use. To maintain the appearance and durability of your appliance we encourage you to read and follow the instructions, hints and warnings included throughout this manual. Care must always be taken to prevent scratches on your appliance from hard or sharp objects.

NOTE: People with sensitivity to cleaning chemicals must take the necessary precautions. St George recommends wearing protective gloves while cleaning the appliance. Routine cleaning of the appliance should only be performed when the appliance is at room temperature.

DO NOT USE ANY ACIDIC OR CAUSTIC CLEANERS, ABRASIVE POWDERS OR SCOURERS ON THE INTERIOR OR EXTERIOR OF THE APPLIANCE. Substances or items with these properties may discolour or damage the finish of your appliance. If any abrasive, acidic or caustic substance or cleaning agent should come into contact with the appliance, rinse off immediately taking special care to avoid injury if surfaces are hot.

5.1 **Recommended Cleaners**

Mild detergents and warm water together with a clean, soft, non-abrasive cloth achieve good results for normal cleaning.

Diluted washes with Ammonia and water should rinse away any adhesive residue or gummy deposits on the appliance surfaces. Eucalyptus oil (small amounts) is also good for removing adhesive residue. Alcohol based products (e.g. Methylated Spirit, etc.) are not recommended.

Brand name cream cleansers and concentrates, without abrasive qualities, can be used in small amounts to break down greasy deposits and dirt.

To prevent any risk of baked on cleaner residues make sure cleaned surfaces are thoroughly rinsed and then wiped dry with a clean, soft cloth.

NOTE: When cleaning stainless steel surfaces St George recommend 3M brand or Advance (by Cleaveland Cleaning Supplies) stainless steel cleaner. Other reputable brand cleaners specifically formulated for cleaning stainless steel may also be acceptable. Do not use steel soap pads or abrasive scourers of any kind. The abrasive qualities of these pads will ruin the even brushed finish of the stainless steel and any residual metal fibres may corrode causing a rusty/dull appearance. Metal polishes with abrasive qualities are also not recommended.

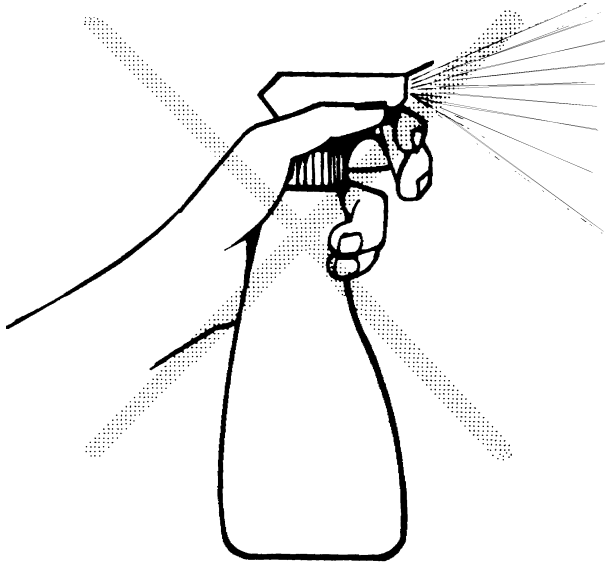

caustic sprays

**DO NOT USE ANY ACID OR CAUSTIC
CLEANSERS OR ABRASIVE POWDERS
OR SCOURERS ON THE INTERIOR
OR EXTERIOR OF THE APPLIANCE**

abrasive powder



oven spray

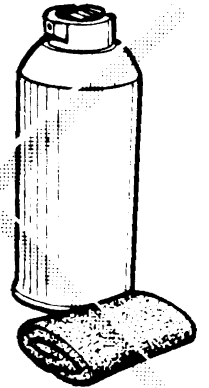

abrasive sponge

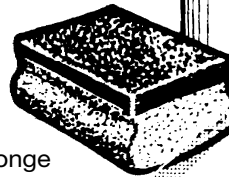

steel wool

5.2 Routine Cleaning

If possible, the oven should be wiped down after each use to prevent dirt and grease build up. Ensure all controls are off and the appliance is cool before cleaning. To clean the oven exterior, wipe the control panel, handles, glass, stainless steel and enamel surfaces regularly using a warm, damp, non-abrasive cloth. Mild detergents may be safely used on all of these surfaces. When wiping stainless steel surfaces that have a brushed finish, wipe in the same direction as the brushing.

Cleaning the oven is made simple with St George's high quality vitreous enamel. To clean the oven interior, fully open (side opening door/s) or remove the door/s (downward opening type, see **Removing Oven Door**) for better access while cleaning. The shelves and shelf guides can be lifted out for cleaning by removing the relevant thumbscrews. The shelves and shelf guides can be washed by hand or in a dishwasher. The fan cover can be lifted out for cleaning separately by removing the thumbscrews retaining it in place. The fan blade can also be removed for cleaning if necessary. Note that the fan blade nut has a left-handed thread.

Wipe out the oven compartment/s with a warm, damp, non-abrasive cloth. Mild detergents may be safely used on the oven interiors. Do not forget the inside top and back of the oven/s and the back of the oven door/s. If using commercial oven cleaners, choose only non-caustic cleaners and follow the manufacturer's instructions. Avoid contact with elements, rubber door seals and exterior surfaces.

Make sure all cleaned surfaces are thoroughly rinsed and then wiped dry with a clean, soft cloth.

5.3 Spills, Spatters and Accidents

When using the appliance, it may be soiled by food spills and spatters or foreign items such as plastics accidentally coming into contact with warm or hot surfaces. Some foods, such as fruit juices (especially citrus juices like lemon juice) and vinegar's (i.e. acidic substances) or sugar or foods containing sugar can discolour or damage enamel finishes.

The enamel interior of your St George oven has a hard durable finish, resistant to wear and discoloration. However, to maintain the appearance and durability of the finish any spills must be wiped off immediately. This should be done as soon as possible and necessary precautions must be taken to avoid injury from hot surfaces. Once cool the affected area should be thoroughly cleaned and rinsed using non-abrasive, mild cleaning detergents and water.

WARNING: USE OF ALUMINIUM FOIL IN OVENS

The use of aluminium foil on the base of the oven to collect spills and improve cleaning is not recommended. The bottom element of St George ovens is concealed under the base of the oven liner (not exposed). **Foil or dishes with reflective qualities must never be placed on the base of the oven during cooking as the concentration of the direct and reflected heat will damage the enamel surface. Damage resulting from such use is not covered under the provisions of the warranty.**

NOTE: To fully preserve the enamelled finish of the grill pan supplied with your appliance, make sure that it is properly lined (e.g. with aluminium foil) when used for grilling or baking fish and other foods with high acid content such as fatty meats and fruits.

5.4 Cleaning the Roast Probe

After each use, the roast probe should be wiped with a warm, damp cloth and mild detergent, if necessary. The roast probe is manufactured from stainless steel, with a special rubber casing for the electrical components. Because of this the roast probe **MUST NEVER BE IMMERSSED IN WATER.**

5.5 **Removing Oven Door (downward opening door models only)**

The oven door can be easily removed for better access while cleaning. To remove the oven door:-

1. Open the door fully and pull the clips toward you onto the hooks.
2. Raise the door slightly and, holding the sides of the door about half way up and making sure the clips stay on the hooks, lift the door gently. This should disconnect the hinges from the oven frame.
3. Remove the door by continuing to raise it while pulling the door away from the oven. When handling the door be careful not to dislodge the clips off the hooks. If so the hinge will have to be closed by hand and the clip re engaged onto the hook before re-fitting onto the oven.

To re-fit the oven door:-

1. Holding the door at an angle to the oven, slide the hinges into the oven frame, making sure that on each side the top, curved arm fits into the top slot and the lower arm fits into the bottom slot.
2. Make sure the hinges are pushed in as far as they will go and the lower arm engages into the plate mounted in the oven frame.
3. Open the door completely and disengage the clips from the hooks. You may need to push the clips down with your finger if they do not fall away from the hook by themselves. The door can now be opened and closed as normal.

5.5.1 **Door Glass Removable**

The piece of glass on the back of the door can be removed for cleaning. To remove the glass from the door back:

1. Open the oven door fully
2. Use a coin or screwdriver to loosen the 2 fixing screws.
Side Opening Doors: Take care the glass does not fall when loosening the screws.
3. The glass can be removed for cleaning.

Do not lose the silicon washer and sleeve, these parts are there to protect the door back and glass from damage.

Installation is the reverse of removal. Ensure that the silicon washer and sleeve are replaced. The fixing screws need only be firmly finger tight. Do not over tighten.

REMOVAL & REPLACEMENT OF OVEN DOOR (DOWNWARD OPENING DOORS ONLY)

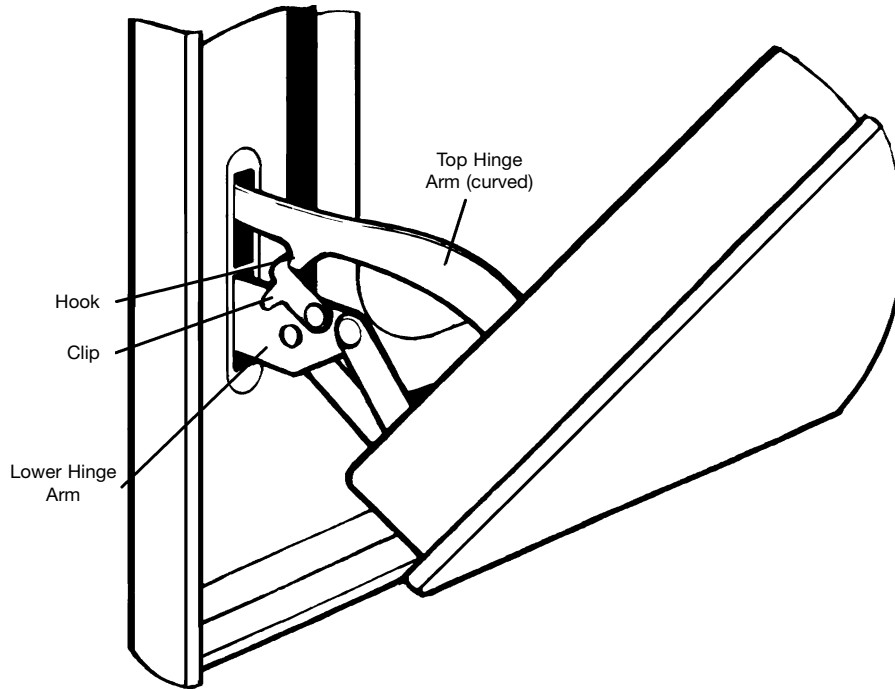

5.6 Self Clean Oven Liners

An Optional Self Clean Oven Liner Kit is available as an accessory which, when fitted into the oven, catalyses cooking fats which come into contact with their surfaces during oven operation. The fats burn and flake to the oven floor so a quick brush out when the oven is cool is all that's required. The non-liner surfaces in the oven can then be wiped down for brilliantly simple results. For extra cleaning action, heat the empty oven at 230°C for 15 to 20 minutes.

Be very careful not to scratch the surfaces of the liners. Large spills should be removed by sponging the liners using warm water and a soft sponge. If large areas of the catalytic coated liners are covered with cooking fats the self cleaning action may not be as effective. The catalytic liners can be cleaned by removing them from the oven and rinsing with **clear hot water** only. Cleansing agents or oven cleaners must never be used on the self-clean liners.

5.7 Changing the Light Globe

The oven illumination lamp/s are located in the side wall/s of the oven compartment/s. The light globe is located behind the glass cover and is a screw-in type.

Ensure that the appliance is switched off before replacing the lamp to avoid the possibility of electric shock.

To change a light globe:-

1. Gently lever out the glass cover from the rear edge.
2. Unscrew the light globe and screw in a replacement globe.
3. Replace the glass cover making sure it fits correctly into place.

5.8 TROUBLE SHOOTING GUIDE

SYMPTOM	REMEDY
<p>No power supplied to appliance</p> <p>Oven power is on but appliance does not operate.</p> <p>Oven power is on but there is no heat</p> <p>Rubber seal has gap/s at bottom and ends do not meet.</p> <p>Display is flashing, is only partly illuminated or is cycling through various displays</p>	<p>Has the mains been disconnected. Check meter box, has the mains fuse or circuit breaker blown or tripped.</p> <p>Oven may be set on Automatic (See Automatic Programmed Cooking)</p> <p>Oven may be set on Automatic. Mode may be on incorrect selection.</p> <p>Correct — some doors sealed this way for oven venting purposes.</p> <p>Turn power supply to appliance off, wait 30 seconds and turn power back on. Wait 90 seconds before resetting clock and using appliance.</p>

IF YOU HAVE A PROBLEM WITH YOUR ST GEORGE APPLIANCE WHICH CANNOT BE OVERCOME USING THE INFORMATION PROVIDED IN THIS MANUAL AND REQUIRE A SERVICE CHECK, PLEASE CONTACT THE RELEVANT OFFICE IN YOUR STATE — for contact details see over.

To ensure prompt and efficient service please have the following details ready before making your call:-

Model Number
Serial Number

Date and Place of Purchase
Warranty Registration Number (if applicable)

SERVICE CENTRES AND AGENCIES

AUSTRALIA WIDE	Freecall	1 800 811 278
NEW ZEALAND	Applico	09 574 1050
CANADA/USA	Euroline Appliances	905 829 3980

6. CABINET INSTALLATION INSTRUCTIONS

Your safety and the proper care of your appliance is extremely important. Incorrect installation of the appliance as a result of not following the detailed specifications can affect the appliances performance. Ovens incorrectly installed may invalidate the warranty and we strongly recommend that the oven cavity, venting and wiring be prepared as described in the specifications. This is critical to appearance, oven performance and safety.

WARNING: Installation must comply with Standards Australia (within Australia) Wiring Rules as well as your local electrical and building codes and regulations and any other applicable requirements.

Your appliance must be properly installed and grounded by a qualified technician.

6.1 Measurements

Unless otherwise noted, all dimensions provided are in millimetres (mm). The sizes allow for only a small degree of error so all cut outs must be precise and square. To ensure the cabinetry is well finished the cut edges must also be square and care taken to ensure the cut edges are free of chips.

6.2 Preparing the Cupboard Cavity

ST GEORGE OVENS MUST BE INSTALLED IN ADEQUATELY VENTED CABINETS. ALL ST GEORGE OVENS MUST BE INSTALLED ON BASE SUPPORT STRIPS ON EACH SIDE OF THE OVEN CABINET WITH A VOID LEFT IN THE SPACE BETWEEN THEM. THE SUPPORT STRIPS MUST BE NO MORE THAN 100 mm IN WIDTH AND OF SUFFICIENT STRENGTH TO SUPPORT THE OVEN. ANY CABINETS BUILT TO HOUSE OVENS MUST HAVE APPROPRIATE OPENINGS TO ALLOW INCOMING AIR INTO THE SPACE BELOW THE OVEN SUPPORTS. UNDER NO CIRCUMSTANCES SHOULD A "FULL FLOOR" OVEN CABINET BE USED, AS VENTILATION UNDER THE OVEN IS CRITICAL TO PERFORMANCE. FOR REAR VENTED WALL OVENS, PLEASE NOTE THE ADDITIONAL FLUE REQUIREMENTS

Refer to the Building-In Options for diagrams of the various mounting options applicable.

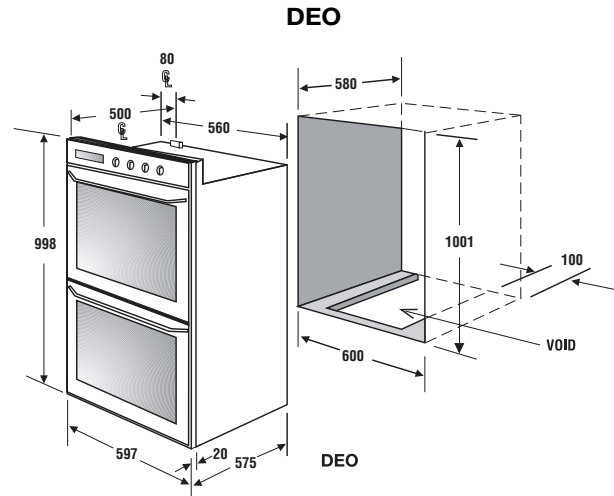
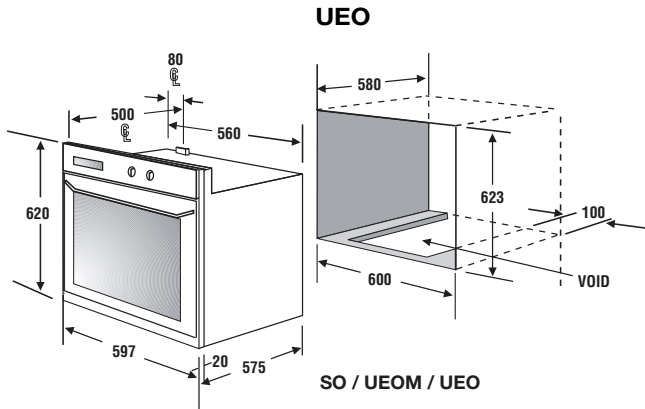

NB: The dimensions shown here are integrated flush-mounted as recommended by St George.

NB: The dimensions shown here are integrated flush-mounted as recommended by St George.

For dimensions of other installation types see chart.

For dimensions of other installation types see chart.

Installation Method	Dimensions		
	H	W	D
Flush	623	600	580
Trim Exposed	618	564	560

Installation Method	Dimensions		
	H	W	D
Flush	1001	600	580
Trim Exposed	996	564	560

H = HEIGHT, W = WIDTH, D = DEPTH

H = HEIGHT, W = WIDTH, D = DEPTH

UES

ELECTRICAL LOADS

The maximum electrical loading for the appliance is 4.3kW.

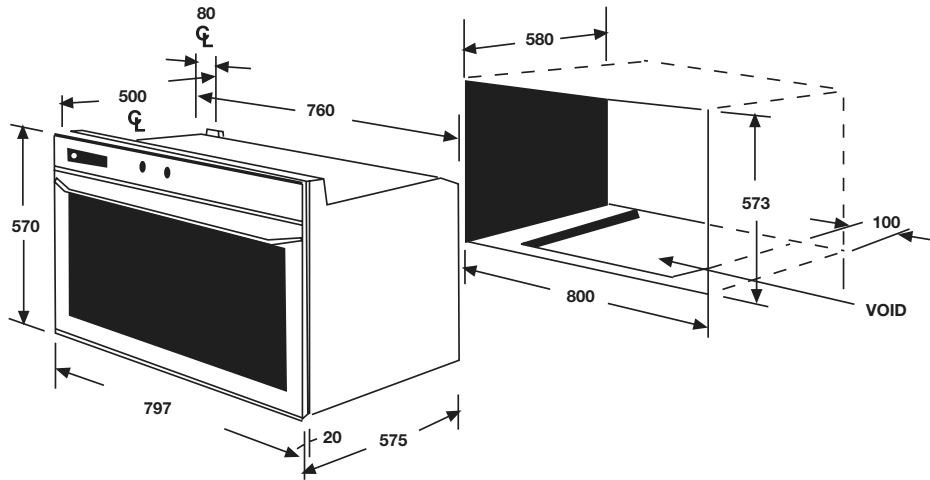

NOTE: The dimensions shown here are integrated flush-mounted as recommended by St. George.

For dimensions of other installation types see chart below.

	HEIGHT	WIDTH	DEPTH
FLUSH	573	800	580
TRIM EXPOSED	565	764	560

BUILDING-IN OPTIONS APPLICABLE ALL OVENS

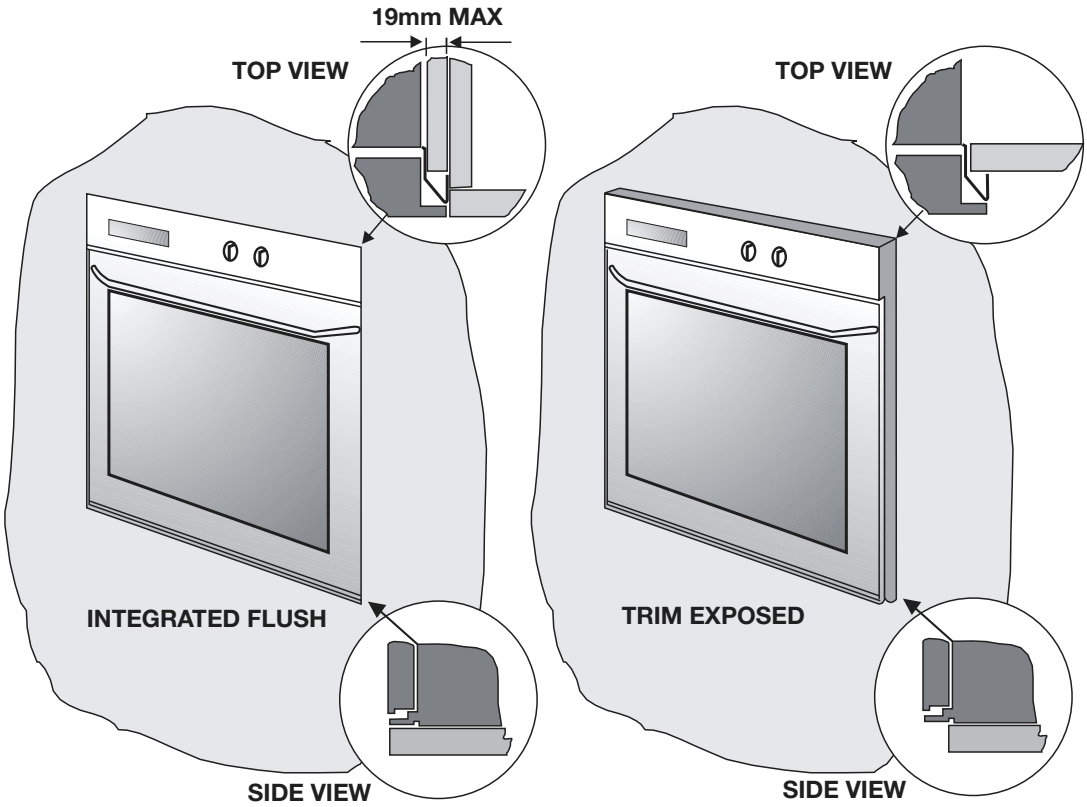

Installation Addendum – Wall Ovens

When wall ovens are installed in situations in conjunction with vacuum formed vinyl/plastic materials, formed onto a base material, it is essential to avoid direct radiation onto these surfaces and edges of doors and panels adjacent to the sides and top of the wall oven.

It is recommended that a heat barrier be fitted to avoid this radiated heat.

See also page 3 of the St. George Specifications and Ratings Literature, this also covers this requirement.

Following are two methods of protecting the doors or panels to the side of the oven, and one to protect the cabinets above the oven.

No responsibility can be accepted for any claims regarding the surrounding doors and panels, if the installation is not to St. George Appliances and the manufacturer of the doors and panels, recommended method of Installation.

Recommended Method of Installation (Diagram)

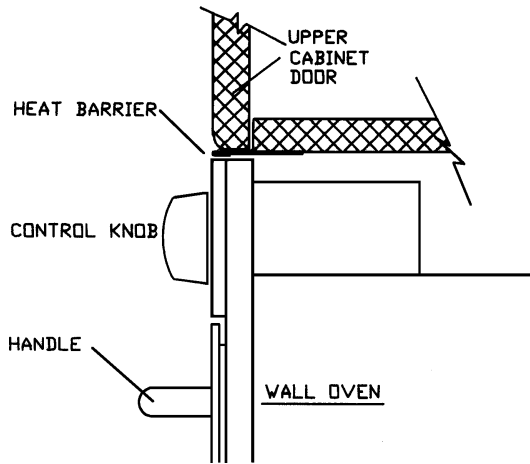

Oven Top

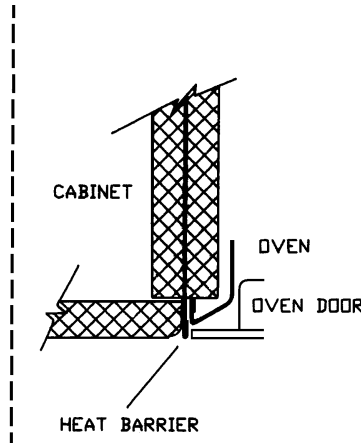

Oven Side

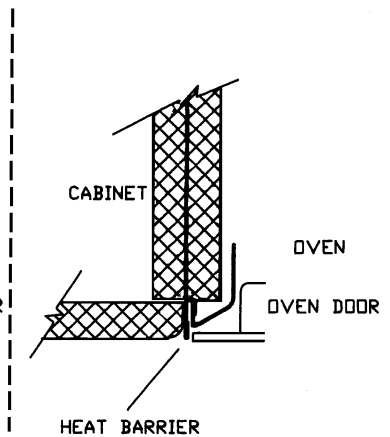

Oven Side
(Alternative)

6.3 Providing a Suitable Flue

UEO and UES Models

A venting fan is fitted at the top rear of the oven and is operational when the oven is on. This fan recirculates air and blows it through vent holes under the control panel fascia. Air vented from the oven will also be passed forward into the room as, in most under bench installations, rear venting is not possible. Whilst the oven is designed to flue in this manner, additional holes may be provided in adjoining cupboard walls and/or the rear wall to further assist air movement.

The oven can be converted to be top vented if required. To convert the unit, locate the rectangular punched detail at the rear right hand side of the top cover (with the oven back toward you). Cut the rear tags holding the vent flap and fold the vent flap down and forward to a vertical position. This will expose the oven vent. Once converted the oven fumes must then be vented according to the venting instructions for wall mounted ovens (i.e. DEO models).

DEO Models

Oven fumes must never be vented into combustible materials. Heat and vapours discharging from the rear oven flue pipe must be allowed to dissipate to an area preferably out of the kitchen. This should be according to your local electrical and building requirements and can be to the roof space, through a wall vent or through the roof space to external atmosphere. Alternatively, it can be recirculated back into the room.

Straight flue pipes must have a minimum diameter of 75 mm. If the flue has any bend or angle, the pipe diameter must be increased to at least 100 mm. Bends must always have the maximum possible angle of rise (i.e. as near to vertical as possible) to provide air movement.

WARNING: Flues must commence within 25 mm of the oven flue pipe. All flue pipes and any heat shields must be at least 25 mm from any combustible materials.

6.4 Securing the Oven

Once correctly wired into (while electrically isolated from) the main power, locate the oven into the recess and ensure the appliance is parallel to the front fascia of the enclosure, adjust the bearers if necessary. Four screws are supplied to secure the oven to the cupboard cavity. The four screw holes are in the oven frame surrounds (visible when you open the oven door/s). Slide the oven fully into the recess and insert the four screws through the mounting holes and into the cupboard surround to secure the oven in position. (Refer to the Installation Diagrams and Building-In Options for diagrams of the various mounting options applicable)

CABINET INSTALLATION INSTRUCTIONS

Flueing Options – DEO & TOP VENTED UEO Models

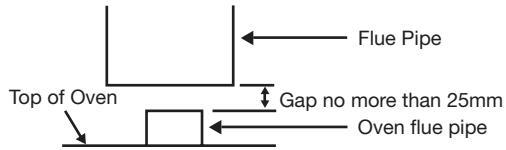

Flue pipe venting to external atmosphere

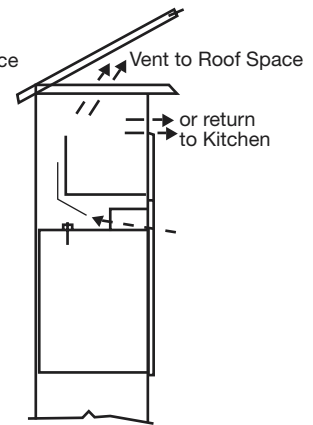
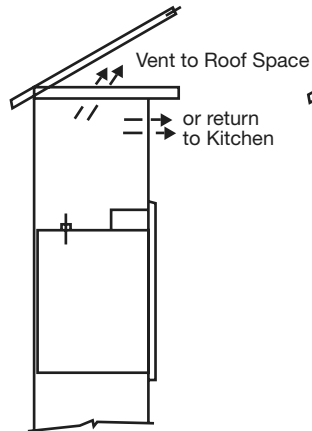
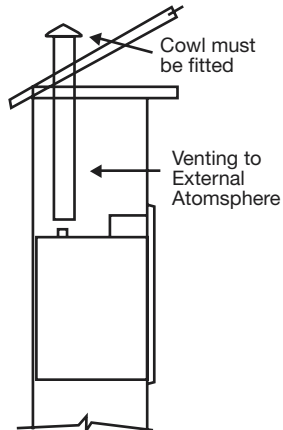
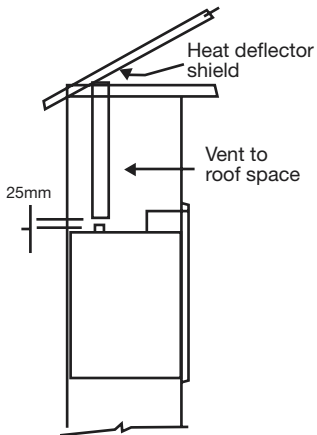
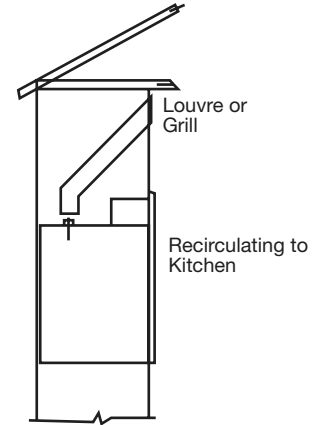
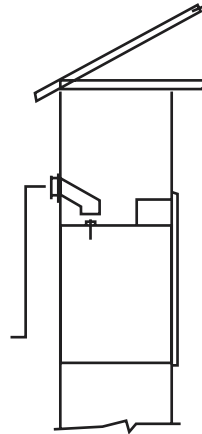

ELECTRICAL CONNECTION INSTRUCTIONS

7. ELECTRICAL CONNECTION INSTRUCTIONS

7.1 Wiring Rules and Warnings

WARNING: All aspects of the installation must conform with the requirements of the Standards Australia (within Australia) Wiring Rules as well as your local electrical and building codes and regulations and any other applicable requirements and conditions of your Local Power Supply Authority. A licensed electrician must perform the electrical work when installing this appliance. The supply cable and fuse rating must be suitable for the appliance.

WARNING: To avoid mains borne interference, this appliance must be installed individually on a separate and distinct final sub-circuit.

NOTE: To the Electrician - please ensure sufficient supply cable is provided to allow the appliance to be removed from the cavity should any servicing be necessary. This will also allow easy connection of the supply.

7.2 Electrical Loads

MAIN OVEN	UEO	DEO	UES
Oven (Max.)	3800 W	3800 W	4200W
Grill	2700 W	2700 W	3500W
Oven Fan and Light	100 W	100 W	100W
SECONDARY OVEN			
Oven	–	2400 W	–
Grill	–	2700 W	–
Oven Light	–	30 W	–
Total Rating	3.9 kW	6.63 kW	4.3 kW

When connected to a subcircuit protected by a circuit breaker, the current drawn by an oven may cause the circuit breaker to trip in some cases. It is recommended that the following installation procedures are used.

When connected to a subcircuit protected by a circuit breaker, the current drawn by an oven may cause the circuit breaker to trip in some cases. It is recommended that the following installation procedures are used.

Model	kW Rating	Maximum Current (Amperes)	Recommendation	
			Cable Size	Circuit Breaker
UEO	3.9	16.3	2.5mm ²	20Amp
DEO	6.63	27.6	4.0mm ²	30Amp
UES	4.3	18.0	2.5mm ²	20Amp

7.3 Voltage Supply Connection

To connect the electrical supply:-

1. Ensure the supply cable and fuse ratings are suitable for the appliance (see Electrical Loads).
2. Remove the cover plate by undoing the screw.
3. Fit a suitable entry bush to the conduit entry bracket and feed the fixed wiring through.
4. Connect the wiring to the terminal block using the screw connections provided. Ensure the wires are properly secured to prevent any high resistance electrical connection.
5. Replace the cover plate using the screw making certain that all wiring is clear of any metal work and the screws.

AUSTRALIA

St. George Appliances
South Sydney Corporate Park
Letterbox No. 3
184 Bourke Road
Alexandria NSW 2015
Phone: 1300 652 100

NEW ZEALAND

The Applico Group Ltd
120 Captain Springs Road
Onehunga, Auckland
New Zealand
Phone: (09) 574 1050
Fax: (09) 574 1051

CANADA

Euro-Line Appliances
2150 Winston Park Drive
Oakville, Ontario L6H 5V1
Phone: (905) 829 3980
Fax: (905) 829 3985

Kleenmaid Pty Ltd

ACN 001 905 808

Trading As

St George Appliances

A Tradition of Excellence

5 Year Warranty

Proudly Australian Made