

# cooking collection

---

Instructions for use and warranty details

Induction Cooktop  
Model No.: ICT6020

 **kLEENmaid**

Dear Customer,

Thank you and congratulations for choosing Kleenmaid.

Your new appliance has been designed and meticulously tested to ensure that it meets all your culinary requirements, and has been carefully manufactured using top quality materials to give you years of reliable performance.

For best results, carefully read the instructions on how your new appliance is to be installed. Correct installation will avoid delays and unnecessary service call costs.

Once installation is complete, please read this instruction manual carefully and get to know the controls and the features of your new Kleenmaid appliance. These simple instructions will enable you to achieve excellent results from the very first time you use it.

Again, congratulations and thank you for choosing The Best You Can Own.

KLEENMAID

---

## **Safety Warnings**

Your safety is important to us. Please read this information before using your cooktop.

## **Installation**

### **Electrical Shock Hazard**

- Disconnect the appliance from the mains electricity supply before carrying out any work or maintenance on it.
- Connection to a good earth wiring system is essential and mandatory.
- Alterations to the domestic wiring system must be only made by a qualified electrician.
- Failure to follow this advice may result in electrical shock or death.

### **Cut Hazard**

- Take care - panel edges are sharp.
- Failure to use caution could result in cuts or other injury.

### **Important safety instructions**

- Read these instructions carefully before installing or using this appliance.
- No combustible material or products should be placed on this appliance at any time.
- Please make this information available to the person responsible for installing the appliance as it could reduce your installation costs.
- In order to avoid a hazard, this appliance must be installed according to these instructions for installation.

- This appliance is to be properly installed and earthed only by a suitably qualified person.
- This appliance should be connected to a circuit which incorporates an isolating switch providing full disconnection from the power supply in accordance with the wiring rules.
- Failure to install the appliance correctly could invalidate any warranty or liability claims.

## **Operation and Maintenance**

### **Electrical Shock Hazard**

- Do not cook on a broken or cracked cooktop. If the cooktop surface should break or crack, switch the appliance off immediately at the mains power supply (wall switch) and contact a qualified technician.
- Switch the cooktop off at the wall before cleaning or maintenance.
- Failure to follow this advice may result in electrical shock or death.

### **Health Hazard**

- This appliance complies with electromagnetic safety standards.

### **Hot Surface Hazard**

- During use, accessible parts of this appliance will become hot enough to cause burns.
- Do not let your body, clothing or any item other than suitable cookware contact the glass until the surface is cool.

- Metallic objects such as knives, forks, spoons and lids should not be placed on the hob surface since they can get hot.
- Keep children away from the hob when in use.
- Handles of saucepans may be hot to touch. Check that saucepan handles do not overhang other active cooking zones. Keep handles out of reach of children.
- Failure to follow this advice could result in burns and scalds.

### **Cut Hazard**

- The razor-sharp blade of a cooktop scraper is exposed when the safety cover is retracted. Use with extreme care and always store safely and out of reach of children.
- Failure to use caution could result in cuts or other injury.

### **Important safety instructions**

- Never leave the appliance unattended when in use. Boilover causes smoking and greasy spills that may ignite.
- Never use your appliance as a work or storage surface.
- Never leave any objects or utensils on the appliance.
- Never use your appliance for warming or heating the room.
- After use, always turn off the cooking zones and the cooktop as described in this manual (i.e. by using the touch controls).

- Do not allow children to play with the appliance or sit, stand, or climb on it.
- Do not store items of interest to children in cabinets above the appliance. Children climbing on the cooktop could be seriously injured.
- Do not leave children alone or unattended in the area where the appliance is in use.
- Do not repair or replace any part of the appliance unless specifically recommended in the manual. All other servicing should be done by a qualified technician.
- Do not use a steam cleaner to clean your cooktop.
- Do not place or drop heavy objects on your cooktop.
- Do not stand on your cooktop.
- Do not use pans with jagged edges or drag pans across the glass surface as this can scratch the glass.
- Do not use scourers or any other harsh abrasive cleaning agents to clean your cooktop, as these can scratch the glass.
- If the supply cord is damaged, it must be replaced by the manufacturer, its service agent or similarly qualified persons in order to avoid a hazard.

- This appliance is intended to be used in household and similar applications such as:
  - staff kitchen areas in shops, offices and other working environments;
  - farm houses;
  - by clients in hotels, motels and other residential type environments;
  - bed and breakfast type environments.
- WARNING:** The appliance and its accessible parts become hot during use. Care should be taken to avoid touching heating elements. Children shall be kept away unless continuously supervised.
- This appliance is not intended for use by persons (including children) with reduced physical, sensory or mental capabilities, or lack of experience and knowledge, unless they have been given supervision or instruction concerning use of the appliance by a person responsible for their safety.
- Children should be supervised to ensure that they do not play with the appliance.
- Cleaning and user maintenance shall not be made by children without supervision.
- WARNING:** Unattended cooking on a hob with fat or oil can be dangerous and may result in fire. NEVER try to extinguish a fire with water, but switch off the appliance and then cover flame e.g. with a lid or a fire blanket.

- WARNING: Danger of fire: do not store items on the cooking surfaces.
  - WARNING: For hob surfaces of glass-ceramic or similar material which protect live parts, if the surface is cracked, switch off the appliance to avoid the possibility of electric shock.
  - A steam cleaner is not to be used.
  - The appliance is not intended to be operated by means of an external timer or separate remote-control system.
- CAUTION: The cooking process has to be supervised. A short term cooking process has to be supervised continuously.

WARNING: Do not use hob guards of any type. The use of inappropriate guards can cause accidents.

This appliance incorporates an earth connection for functional purposes only.



Read all the safety instructions carefully before use and keep this User Manual for future reference.

## Product Overview

### Top View

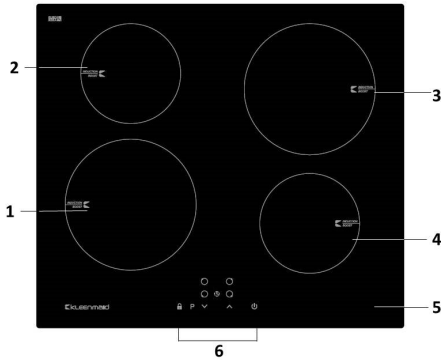

1. 2000/2600 W zone
2. 1500/1800 W zone
3. 2000/2600 W zone
4. 1500/1800 W zone
5. Glass plate
6. Control panel

### Control Panel

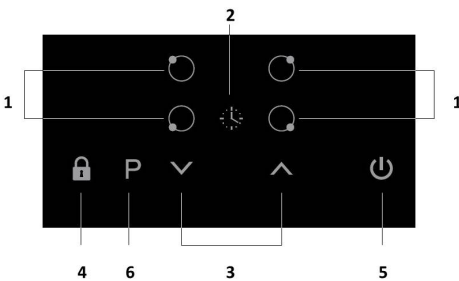

1. Heating zone selection controls
2. Timer control
3. Power/Timer regulating key
4. Child Lock
5. ON/OFF control
6. Boost function control

## An Introduction to Induction Hobs

- Induction cooking is a safe, advanced, efficient, and economical cooking technology. It works by electromagnetic vibrations generating heat directly in the pan, rather than indirectly through heating the glass surface. The glass becomes hot only because the pan eventually warms it up.

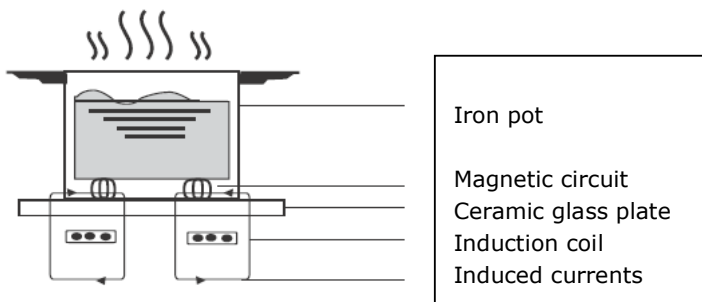

- You need to choose the right cookware for an induction hob, using only cookware with a base suitable for induction cooking.

Look for the induction symbol on the packaging or on the bottom of the pan. You can check whether your cookware is suitable by carrying out the magnet test.

Move a magnet towards the base of the pan. If it is attracted, the pan is suitable for induction. If you do not have a magnet, put some water in the pan you want to check, and then if  $\underline{U}$  does not flash in the display and the water is heating, the pan is suitable.



Cookware made from the following materials is not suitable: pure stainless steel, aluminum or copper without a magnetic base, glass, wood, porcelain, ceramic, and earthenware.

## Before using your New Hob

- Read this guide, taking special note of the 'Safety Warnings' section.
- Remove any protective film that may still be on your hob.
- Do not use cookware with jagged edges or a curved base.



- Make sure that the base of your pan is smooth, sits flat against the glass, and is

the same size as the cooking zone. Always centre your pan on the cooking zone.

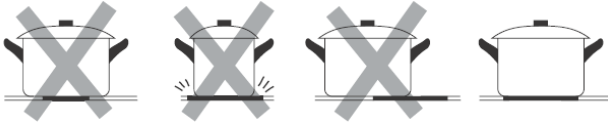

- Always lift pans off the hob – do not slide, or they may scratch the glass.

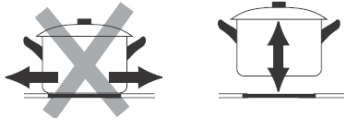

## Using the Touch Controls

- The controls respond to touch, so you don't need to apply any pressure.
- Use the ball of your finger, not its tip.
- You will hear a beep each time a touch is registered.
- Make sure the controls are always clean, dry, and that there is no object (e.g. a utensil or a cloth) covering them. Even a thin film of water may make the controls difficult to operate.

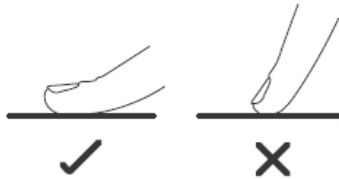

## Using your Hob

### To start cooking

- After power on, the buzzer beeps once, all the indicators light up for 1 second then go out, indicating that the hob has entered the state of standby mode.

1. Touch the ON/OFF control.

After power on, the buzzer beeps once, with all displays showing " - " or " - - ", indicating that the induction hob has entered the state of standby mode.

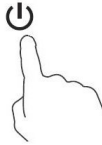

2. Place a suitable pan on the cooking zone that you intend to use.

Make sure the bottom of the pan and the surface of the cooking zone are clean and dry.

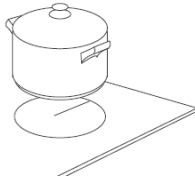

3. Touch the heating zone selection control, and the indicator next to the key will flash.



4. Select a heat setting by touching the "∨" or "∧" control.

- If you don't choose a heat setting within 1 minute, the hob will automatically switch off. You will need to start again at step 1.
- You can modify the heat setting at any time during cooking.
- By holding down either of these buttons, the value will adjust up or down.



**If the display flashes  alternately with the heat setting**

This means that:

- you have not placed a pan on the correct cooking zone or,

- the pan you're using is not suitable for induction cooking or,
- the pan is too small or not properly centred on the cooking zone.

No heating takes place unless there is a suitable pan on the cooking zone. The display will automatically turn off after 1 minute if no suitable pan is placed on it.

## When you have finished cooking

1. Touch the heating zone selection control that you intend to switch off.

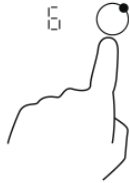

2. Turn the cooking zone off by touching the "v" and "^" sensors at the same time. The display then shows "H".

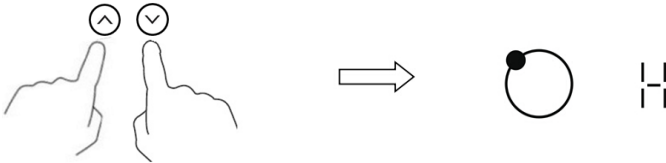

3. Turn the whole cooktop off by touching the "ON/OFF" control.

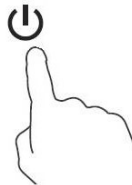

4. Beware of hot surfaces

"H" will show which cooking zone is hot to touch. It will disappear when the surface has cooled down to a safe temperature. It can also be used as an energy saving function. If you want to heat further pans, use the zone that is still hot.



## Using the Boost Function

The Boost function is a function that maximizes power to a selected cooking zone. When activated the function lasts for 5 minutes and provides more powerful, faster cooking eg to heat a large pot of water to cook rice or pasta.

### Using Boost to apply more power

1. Touch the heating zone selection button that you intend to boost, an indicator next to the key will flash.

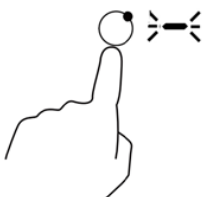

2. Touch the boost button, the heating zone will begin to work at boost mode. The power display will show "P" to indicate that the zone is boosting.

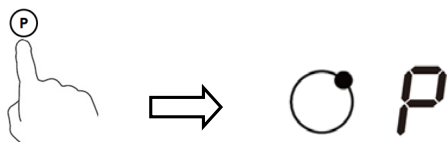

3. The boost power will last for 5 minutes and then the zone will go back to the power level which was set before boost.



4. If you want to cancel the boost during this 5 minutes, touch the heating zone selection button, and an indicator next to the key will flash. Then touch the boost button and the heating zone will go back to the power level which was set before boost.

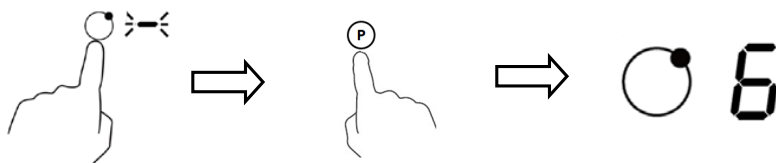

## Locking the Controls

- You can lock the controls to prevent unintended use (for example children accidentally turning the cooking zones on).
- When the controls are locked, all the controls except the ON/OFF control are disabled.

### To lock the controls

Touch the child lock control. The timer indicator will show “Lo”.

### To unlock the controls

1. Make sure the hob is turned on.
2. Touch and hold the keylock control until you hear a beep.
3. You can now start using your hob.



When the hob is in the lock mode, all the controls are disabled except the ON/OFF control. You can always turn the hob off with the ON/OFF control in an emergency, but you should unlock the hob first before the next use.

## Over-Temperature Protection

An inbuilt temperature sensor monitors the temperature inside the hob. When an excessive temperature is detected, the hob will stop operation automatically.

## Detection of Small Articles

When an unsuitable size or non-magnetic pan (e.g. aluminum), or some other small item (e.g. knife, fork, key) has been left on the induction hob, the induction hob automatically goes on to standby in 1 minute. The fan will keep cooling down the induction hob for a further 1 minute.

## Residual Heat Warning

When the hob has been operating for some time, there will be residual heat. The letter “H” appears as a warning against possible injury from hot surfaces.

## Auto Shutdown Protection

Auto shut down is a safety protection function for your induction hob. It shuts down automatically if you forget to turn off power to a cooking zone. The default shutdown times are shown in the table below:

<b>Power level</b>	1	2	3	4	5	6	7	8	9
<b>Default working timer (hour)</b>	8	8	8	4	4	4	2	2	2

## Using the Timer

You can use the timer in two different ways:

- You can use it as a minute minder. In this case, the timer will not turn any cooking zone off when the set time expires.
- You can set it to turn one or more cooking zones off after the set time expires.
- You can set the timer for up to 99 minutes.

### Using the Timer as a Minute Minder

#### If you are not selecting any cooking zone

1. Make sure the cooktop is turned on.

Note: you can use the minute minder even if you're not selecting any cooking zones.

2. Touch the timer control, and the timer indicator will show "--".

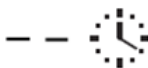

3. To adjust the timer setting touch the "v" or "^" controls. The minute minder indicator will start flashing and will show in the timer display.

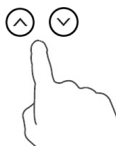

Hint:

Touch the "v" or "^" control of the timer once to decrease or increase by 1 minute.

Touch and hold the "v" or "^" control of the timer to decrease or increase by 10 minutes.



If the setting time exceeds 99 minutes, the timer will automatically return to 0 minutes.

4. Touch the 'Timer', the timer is cancelled, and the "00" will show in the minute display.

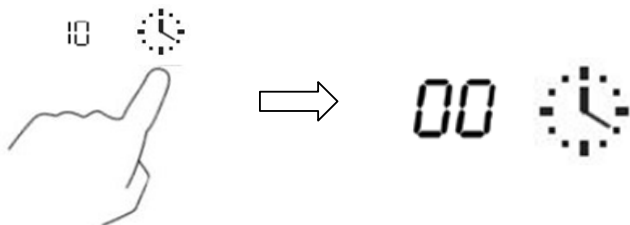

5. When the time is set, it will begin to count down immediately. The display will show the remaining time and the timer indicator will flash for 5 seconds.

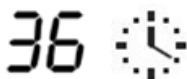

6. When the set time is finished the buzzer will beep for 30 seconds and the timer indicator will show "--".

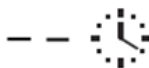

NOTE: The hob/cooktop will continue to cook. This timer function is a minute minder only. It does not turn the cooktop ON or OFF.

## Setting the timer to turn one cooking zone off

1. Touch the heating zone selection control that you want to set the timer for. (e.g. zone 3#)



2. Touch timer control, the minder indicator will start flashing and "30" will show in the timer display



3. Set the time by touching the control of the timer.



Hint:

Touching the "v" or "^" control of the timer once will decrease or increase by 1 minute.

Touch and hold the "v" or "^" control of the timer to decrease or increase by 10 minutes.

If the setting time exceeds 99 minutes, the timer will automatically return to 0 minutes.

4. Touch the heating zone selection control, and then touch the "Timer", the timer is cancelled, and the "--" will show in the minute display.

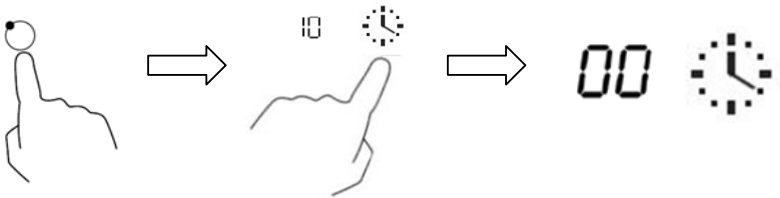

5. When the time is set, it will begin to count down immediately. The display will show the remaining time and the timer indicator flash for 5 seconds.

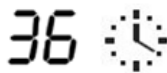

NOTE: The red dot next to power level indicator will illuminate indicating that zone is selected.



6. When cooking time expires, the corresponding cooking zone will be switched off automatically.

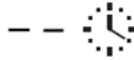

Note: Other cooking zones turned on previously will keep operating.

## Setting the timer to turn more than one cooking zone off

1. If the function is used for more than one heating zone, the indicator will show the lowest time.

(e.g. zone 2# setting time of 3 minutes, zone 3# setting time of 6 minutes, the timer indicator shows "3".)

NOTE: The red dot next to power level indicator will flash.

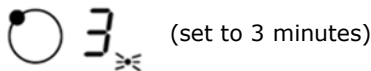
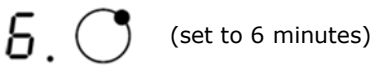

2. When cooking time expires, the corresponding cooking zone will be switch off automatically.



NOTE: If you want to change the time after the timer is set, start again from step 1.

## Cooking Guidelines



Take care when frying as the oil and fat heat up very quickly, particularly if you're using the Boost function of the induction hob. At extremely high temperatures, oil and fat will ignite spontaneously and this presents a serious fire risk.

### Cooking Tips

- When food comes to the boil, reduce the power setting.
- Using a lid will reduce cooking times and save energy by retaining the heat.
- Minimise the amount of liquid or fat to reduce cooking times.
- Start cooking on a high setting and reduce the setting when the food has heated through.

### Simmering, cooking rice

- Simmering occurs below boiling point, at around 85°C, when bubbles are just rising occasionally to the surface of the cooking liquid. It is the key to delicious soups and tender stews because the flavours develop without overcooking the food. You should also cook egg-based and flour-thickened sauces below boiling point.
- Some tasks, including cooking rice by the absorption method, may require a setting higher than the lowest setting to ensure the food is cooked properly in the time recommended.

### Searing steak

To cook juicy flavoursome steaks:

1. Stand the meat at room temperature for about 20 minutes before cooking.
2. Heat up a heavy-based frying pan.
3. Brush both sides of the steak with oil. Drizzle a small amount of oil into the hot pan and then lower the meat onto the hot pan.
4. Turn the steak only once during cooking. The exact cooking time will depend on the thickness of the steak and how cooked you want it. Times may vary from about 2 – 8 minutes per side. Press the steak to gauge how cooked it is – the firmer it feels the more 'well done' it will be.
5. Leave the steak to rest on a warm plate for a few minutes to allow it to relax

and become tender before serving.

**For stir-frying**

1. Choose an ceramic compatible flat-based wok or a large frying pan.
2. Have all the ingredients and equipment ready. Stir-frying should be quick. If cooking large quantities, cook the food in several smaller batches.
3. Preheat the pan briefly and add two tablespoons of oil.
4. Cook any meat first, put it aside and keep warm.
5. Stir-fry the vegetables. When they are hot but still crisp, turn the cooking zone to a lower setting, return the meat to the pan and add your sauce.
6. Stir the ingredients gently to make sure they are heated through.
7. Serve immediately.

## Heat Settings

Heat setting	Suitability
1 - 2	<ul style="list-style-type: none"><li>• delicate warming for small amounts of food</li><li>• melting chocolate, butter, and foods that burn quickly</li><li>• gentle simmering</li><li>• slow warming</li></ul>
3 - 4	<ul style="list-style-type: none"><li>• reheating</li><li>• rapid simmering</li><li>• cooking rice</li></ul>
5 - 6	<ul style="list-style-type: none"><li>• pancakes</li></ul>
7 - 8	<ul style="list-style-type: none"><li>• sauteing</li><li>• cooking pasta</li></ul>
9	<ul style="list-style-type: none"><li>• stir-frying</li><li>• searing</li><li>• bringing soup to the boil</li><li>• boiling water</li></ul>

## Care and Cleaning

What?	How?	Important!
<p>Everyday soiling on glass (fingerprints, marks, stains left by food or non-sugary spillovers on the glass)</p>	<ol style="list-style-type: none"> <li>1. Switch the power to the cooktop off.</li> <li>2. Apply a cooktop cleaner while the glass is still warm (but not hot!)</li> <li>3. Rinse and wipe dry with a clean cloth or paper towel.</li> <li>4. Switch the power to the cooktop back on.</li> </ol>	<ul style="list-style-type: none"> <li>• When the power to the cooktop is switched off, there will be no 'hot surface' indication but the cooking zone may still be hot! Take extreme care.</li> <li>• Heavy-duty scourers, some nylon scourers and harsh/abrasive cleaning agents may scratch the glass. Always read the label to check if your cleaner or scourer is suitable.</li> <li>• Never leave cleaning residue on the cooktop: the glass may become stained.</li> </ul>
<p>Boilovers, melts, and hot sugary spills on the glass</p>	<p>Remove these immediately with a fish slice, palette knife or razor blade scraper suitable for ceramic glass cooktops, but beware of hot cooking zone surfaces:</p> <ol style="list-style-type: none"> <li>1. Switch the power to the cooktop off at the wall.</li> <li>2. Hold the blade or utensil at a 30° angle and scrape the soiling or spill to a cool area of the cooktop.</li> <li>3. Clean the soiling or spill up with a dish cloth or paper towel.</li> <li>4. Follow steps 2 to 4 for "Everyday soiling on glass."</li> </ol>	<ul style="list-style-type: none"> <li>• Remove stains left by melts and sugary food or spillovers as soon as possible. If left to cool on the glass, they may be difficult to remove or even permanently damage the glass surface.</li> <li>• Cut hazard: when the safety cover is retracted, the blade in a scraper is razor-sharp. Use with extreme care and always store safely and out of reach of children.</li> </ul>
<p>Spillovers on the touch controls</p>	<ol style="list-style-type: none"> <li>1. Switch the power to the cooktop off.</li> <li>2. Soak up the spill</li> <li>3. Wipe the touch control area with a clean damp sponge or cloth.</li> <li>4. Wipe the area completely dry with a paper towel.</li> <li>5. Switch the power to the cooktop back on.</li> </ol>	<ul style="list-style-type: none"> <li>• The cooktop may beep and turn itself off, and the touch controls may not function while there is liquid on them. Make sure you wipe the touch control area dry before turning the cooktop back on.</li> </ul>

## Hints and Tips

<b>Problem</b>	<b>Possible causes</b>	<b>What to do</b>
The cooktop cannot be turned on.	No power.	Make sure the cooktop is connected to the power supply and that it is switched on. Check whether there is a power outage in your home or area. If you've checked everything and the problem persists, call a qualified technician.
The touch controls are unresponsive.	The controls are locked.	Unlock the controls. See section "Using your hob" for instructions.
The touch controls are difficult to operate.	There may be a slight film of water over the controls or you may be using the tip of your finger when touching the controls.	Make sure the touch control area is dry and use the ball of your finger when touching the controls.
The glass is being scratched.	Rough-edged cookware.  Unsuitable, abrasive scourer or cleaning products being used.	Use cookware with flat and smooth bases. See "Choosing the right cookware".  See "Care and cleaning".
Some pans make crackling or clicking noises.	This may be caused by the construction of your cookware (layers of different metals vibrating differently).	This is normal for cookware and does not indicate a fault.
The induction hob makes a low humming noise when used on a high heat setting.	This is caused by the technology of induction cooking.	This is normal, but the noise should quieten down or disappear completely when you decrease the heat setting.
Fan noise coming from the induction hob.	A cooling fan built into your induction hob switches on to prevent the electronics from overheating. It may continue to run even after you've turned the induction hob off.	This is normal and needs no action. Do not switch the power to the induction hob off at the wall while the fan is running.
Pans do not become hot or appear in the display.	The induction hob cannot detect the pan because it is not suitable for induction cooking.  The induction hob cannot detect the pan because it is too small for the cooking zone or not properly centred on it.	Use cookware suitable for induction cooking. See section "An Introduction to Induction Hobs".  Centre the pan and make sure that its base matches the size of the cooking zone.

The induction hob or a cooking zone has turned itself off unexpectedly, a tone sounds and an error code is displayed (typically alternating with one or two digits in the cooking timer display).	Technical fault.	Please note down the error letters and numbers, switch the power to the induction hob off at the wall, and contact a qualified technician.
---	------------------	--

## Failure Display and Inspection

If an abnormality comes up, the induction hob will enter the protective state automatically and display corresponding protective codes:

<b>Problem</b>	<b>Possible causes</b>	<b>What to do</b>
F3/F4	Temperature sensor of the induction coil failure	Please contact the supplier.
F9/FA	Temperature sensor of the IGBT failure.	Please contact the supplier.
E1/E2	Abnormal supply voltage	Please inspect whether power supply is normal. Power on after the power supply is normal.
E3	High temperature of the induction coil temperature sensor	Please contact the supplier.
E5	High temperature of the IGBT temperature sensor	Please restart after the hob cools down.

The above are the possible causes of and appropriate responses to common failures. Please do not disassemble the unit by yourself to avoid any danger and damage to the hob.



## Technical Specification

Cooking Zones	4 Zones
Supply Voltage	220-240V~,50-60Hz
Total Power	6600-7200W
Product Size L×W×H(mm)	590*520*55
Building-in Dimensions (mm)	A×B 560*490

Weight and Dimensions are approximate. Because we continually strive to improve our products we may change specifications and designs without prior notice.

## Installation

### Selection of installation equipment

Cut out the work surface according to the sizes shown in the drawing.

For the purpose of installation and use, a minimum of 50mm space shall be preserved around the hole.

Be sure the thickness of the work surface is at least 30mm. Please select heat-resistant work surface material to avoid larger deformation caused by the heat radiation from the hotplate. As shown below:

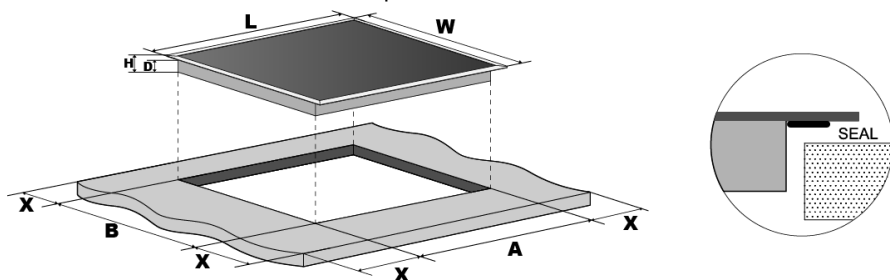

Model	L (mm)	W (mm)	H (mm)	D (mm)	A (mm)	B (mm)	X (mm)
YL-IF7003	590	520	55	51	560	490	50mini.

Under all circumstances, make sure the induction hob is well ventilated and the air inlet and outlet are not blocked. Ensure the induction hob is positioned correctly as shown below.



Note: The safety gap between the hob and the cupboard above the hob should be at least 760mm.

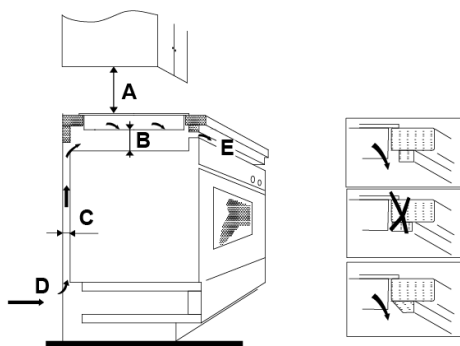

A(mm)	B(mm)	C(mm)	D	E
760	50 mini	30 mini	Air intake	Air exit 10 mm



NOTE: The safety gap between the hob and the rangehood placed above must comply with the recommendations of the rangehood manufacturer. In case of no instructions, a minimum distance of 650mm (or other minimum distance as may be specified by AS/NZS 5601 and interpreted by a certified installer) should apply.

### Before locating the fixing brackets

The unit should be placed on a stable, smooth surface (use the packaging).

Do not apply force onto the controls protruding from the hob.

Fix the hob to the work surface by attaching the four brackets to the bottom of the hob after checking placement within the cut out (see picture).

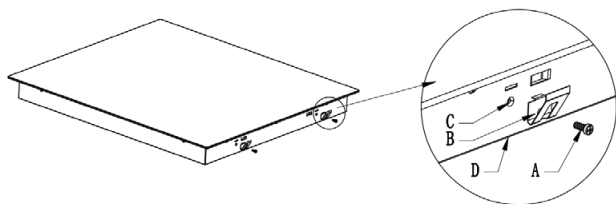

A	B	C	D
screw	bracket	Screw hole	base

Adjust the bracket position to suit for different work surface's thickness.

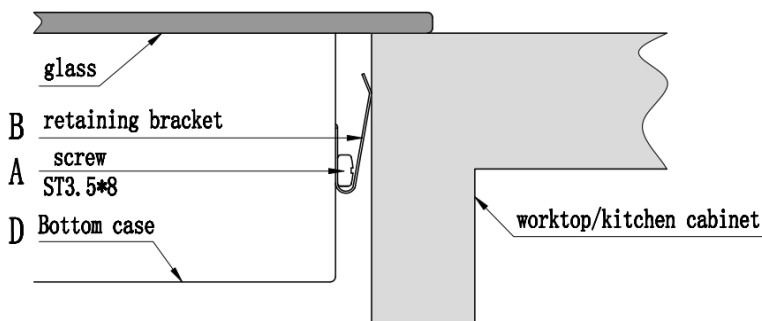

## Cautions

1. The cooktop must be installed by qualified personnel or technicians. If necessary, please see the "Support" section on our website for suitably qualified installers. Unqualified persons should not attempt to install this appliance.
2. The cooktop should not be mounted to cooling equipment, dishwashers or rotary dryers.
3. The cooktop should be installed such that sufficient heat radiation can be ensured to enhance its reliability.
4. The wall and induced heating zone above the work surface should be heat-resistant.
5. To avoid any damage, the sandwich layer and adhesive must be resistant to heat.
6. A steam cleaner is not to be used on this cooktop.
7. This cooktop can be connected only to a supply with system impedance no more than 0.427 ohm. If necessary, please consult your supply authority for system impedance information.

## Connecting the hob to the mains power supply

The power supply should be connected in compliance with the relevant standard, or a single-pole circuit breaker. The method of connection is shown below.

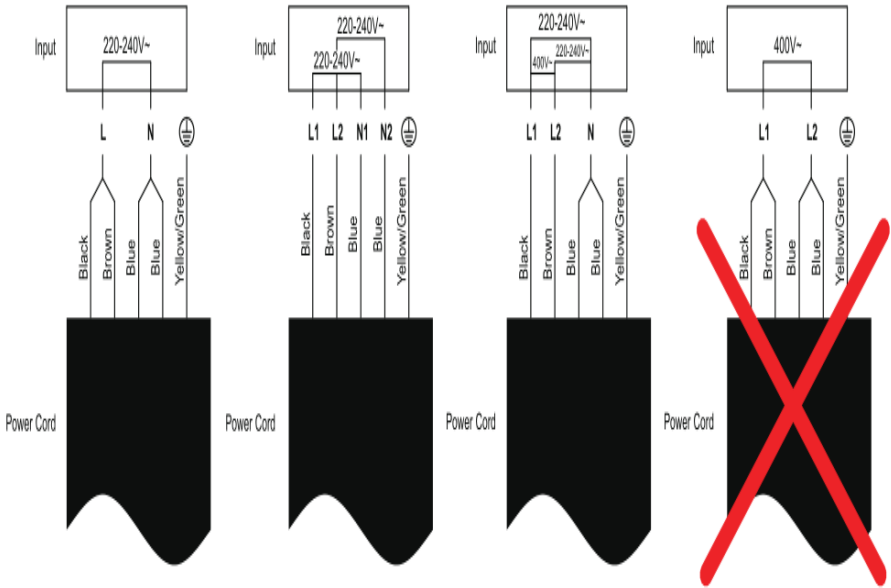

1. If the supply cord is damaged, it must be replaced by the manufacturer, its service agent or similarly qualified persons in order to avoid a hazard.
2. If the appliance is being connected directly to the mains supply, an omnipolar circuit breaker must be installed with a minimum gap of 3mm between the contacts.
3. The installer must ensure that the correct electrical connection has been made and that it complies with safety regulations.
4. The cable must not be bent or compressed.
5. The cable must be checked regularly and only replaced by a properly qualified person.



**DISPOSAL: Do not dispose of this product as unsorted municipal waste. Collection of such waste separately for special treatment is necessary.**

This appliance is labeled in compliance with European directive 2002/96/EC for Waste Electrical and Electronic Equipment (WEEE). By ensuring that this appliance is disposed of correctly, you will help prevent any possible damage to the environment and to human health, which might otherwise be caused if it were disposed of in the wrong way.

The symbol on the product indicates that it may not be treated as normal household waste. It should be taken to a collection point for the recycling of electrical and electronic goods.

This appliance requires specialist waste disposal. For further information regarding the treatment, recover and recycling of this product please contact your local council, your household waste disposal service, or the shop where you purchased it.

# KLEENMAID WARRANTY

## TERMS AND CONDITIONS

1. Compass Capital Services Pty Ltd ABN 96 138 214 525 trading as Kleenmaid will provide parts and labour to you the customer as set out herein.
2. Kleenmaid's Products come with guarantees that cannot be excluded under the Australian Consumer Law. You are entitled to a replacement or refund for a major failure and for compensation for any other reasonably foreseeable loss or damage. You are also entitled to have the goods repaired or replaced if the goods fail to be of acceptable quality and the failure does not amount to a major failure.
3. The benefits given to you under this Kleenmaid Warranty are in addition to other rights and remedies to which you may be entitled under the Australian Consumer Law in relation to the Product to which this Kleenmaid Warranty relates. Subject to the conditions below, the Product is warranted by Kleenmaid and/or its agents to be free from defects in materials and workmanship for the Warranty Period for normal Domestic Use.
4. Product Identification: -
  - a. Kleenmaid reserves the right to reject claims for any services or work where you cannot produce for verification the serial number and a proof of purchase for the Product (including but not limited to the original invoice).
  - b. This Kleenmaid Warranty will be voided if the serial number for the Product cannot be verified. This is not intended to exclude, restrict or modify any right or remedy to which you may otherwise be entitled under the consumer guarantee provisions of the Australian Consumer Law.
  - c. In the event that a request for repair is made against this Kleenmaid Warranty where the serial number for the Product cannot be verified or you cannot produce for verification a proof of purchase for the Product (including but not limited to the original invoice), the repairer will not carry out any repairs on the Product and you will be charged a service call-out fee.
5. What is covered by this Kleenmaid Warranty: -
  - a. The Product is covered for faulty workmanship or parts that have failed under normal Domestic Use.
  - b. Kleenmaid and/or its agents will determine by objective testing if there are any defects in the Product and/or faulty workmanship.
  - c. This Kleenmaid Warranty is only applicable if repairs on Products are carried out within Mainland Australia.
  - d. This Kleenmaid Warranty: -
    - i. covers a Product purchased as new, manufactured for use in Mainland Australia;
    - ii. commences from the date of delivery of the Product;
    - iii. provides for the labour and replacement parts necessary to maintain the Product in good operating condition as specified in this Kleenmaid Warranty, however, if repair is needed because of Product failure during normal Domestic Use, Kleenmaid has the option to repair or replace the defective Product or part of the Product with a product or part of like kind and quality. A replacement part may be new or reconditioned of like kind and quality and may cost less than the original Product purchased and no charges or refunds will be made based on the replacement product or part cost difference; and
    - iv. is only applicable when the Product is used and operated in accordance with the Manufacturer's instructions.
6. What is not Covered by this Kleenmaid Warranty (excluded):-
  - a. any damage or failure to or of the Product or part of the Product:
    - i. due to the Product being inadequately serviced to manufacturer's recommendations;
    - ii. resulting from environmental conditions including and not limited to dirt, dust, rodents, insects, rust, corrosion, salt built-up, of or in any part of the Product;
    - iii. resulting from excessive use but fair wear and tear is excepted;
    - iv. resulting from poor installation including and not limited to positioning and externally fitted equipment such as plumbing and drainage, cabling, antennae or due to incompatibility of connected equipment;
    - v. caused by overheating as a result of siting or positioning of the Product, where there is no provision for adequate ventilation or adequate protection from excessive dust;
    - vi. if the Product has been dismantled, repaired or serviced by any person other than someone authorised by Kleenmaid or its agents or representatives;
    - vii. caused by power surges or spikes, including and not limited to, mains power and telecommunications connections, or to other unspecified sources, incorrect power current, voltage fluctuation, amperage fluctuation, rust or corrosion;
    - viii. if the Product is dropped, collision of the Product with another object, use for which the Product is not designed, damage to the Product caused by your own negligence, accidental or deliberate misuse of the Product by you, theft, abuse, vandalism, flood, fire, earthquake, electrical storms or any other act of God or any war related events; or
    - ix. due to the introduction of abnormal heat loads to the Product;
  - b. costs of attendance and testing where no fault or defect covered by the terms of this Kleenmaid Warranty is identified in the Product;
  - c. initial setup and installation of the Product;
  - d. normal maintenance costs and costs incurred through the installation of items listed as requiring periodic replacement;
  - e. Products with removed or altered serial numbers;
  - f. broken or cracked glass other than transport damage to the initial point of delivery;
  - g. consumables such as but not limited to bulbs/globes, glass, seals, filters, batteries and remote controls;
  - h. removal and reinstallation of an internal component not performed by an authorised Kleenmaid agent or representative or authorised service centre;
    - i. cosmetic or structural items; or
  - j. any failures due to interference from or with other products and/or sources.

7. This Kleenmaid Warranty ceases if: -
  - a. the Product ceases to carry the original manufacturer's serial number or is sold at an auction;
  - b. the Product is rented;
  - c. damage to the Product has occurred as listed in point 7a; or
  - d. there is failure to pay monies owing on invoices as a result of non-warranty work been carried out at the request of the end user as per point 16 below.
8. Neither Kleenmaid nor its representatives provide loan equipment under the terms of this Kleenmaid Warranty.
9. Any unauthorised access to the internal hardware of the Product will void this Kleenmaid Warranty.
10. Repair Notice: Products presented for repair may be replaced by refurbished Products of the same type rather than being repaired. Refurbished parts may be used to repair the Products.
11. Replacement items are "like for like" and is not "new for old" and does not indicate in any way that a faulty Product will be replaced with a new part or unit. "Like for like" may either be a quality checked, refurbished or reconditioned unit of the same or later batch of model/size/specifications
12. The cost of making a claim under this Kleenmaid Warranty is not covered by Kleenmaid, including any costs of transportation or travel expenses between your home and your nearest authorised service agent.
13. Kleenmaid accepts no liability for items that are lost, damaged, or stolen as a result of freight, transport or storage. If you are required to transport the Product to an authorised service centre, you must ensure that it is securely packed and insured.
14. On Public Holidays or other periods when regular business and wholesale operations are temporarily ceased, repairer availability and warranty response times may extend beyond the standard response times due to the unavailability of repairers and parts.
15. For any repair performed on a Product under this Kleenmaid Warranty where no fault can be found, or the item is deemed by Kleenmaid or an authorised agent, to be not faulty under this Kleenmaid Warranty, or the repair or fault is not covered under this Kleenmaid Warranty, a 'No Fault Found' fee is payable by you. Kleenmaid will advise you of this cost and seek your agreement to pay such costs before commencing such repairs.
16. Any repairs or services required that are outside the terms and conditions of this Kleenmaid Warranty can be carried out at your request at your cost (including where the Product has not been installed or set up correctly). Kleenmaid will always advise you of this cost and seek your agreement to pay such costs before commencing such repairs. A credit card may be required prior to the commencement of such services.
17. Extra charges will be payable by the customer should the Product not be readily accessible without special equipment, such as but not limited to cranes and lifts or should the Product be installed in a position that service access is blocked and/or repair work is not possible without uninstalling the Product to gain access.
18. You, the customer, may be entitled to purchase an extended warranty in respect of the Product. Any extended warranty will not be issued by Kleenmaid but by a third party. Any extended warranty services will be provided directly by the third party as principal and not as agent for Kleenmaid, under their extended warranty terms and conditions and not under this Kleenmaid Warranty.
19. To make a claim under this Kleenmaid Warranty, please have your proof of purchase and the serial number of the Product ready and call (02) 9310 1207 during business hours.
20. This Kleenmaid Warranty is given by:
 

Name: Compass Capital Services Pty Ltd ABN 96 138 214 525 trading as Kleenmaid  
 Business address: Level 2, Suite 3, 204 Botany Rd, Alexandria NSW Australia 2115  
 Telephone: (02) 9310 1207
21. Definitions:
  - a. **Australian Consumer Law** means the *Competition and Consumer Act 2010* (Cth).
  - b. **Domestic Use** means use of the Product for personal, domestic or household purposes.
  - c. **Kleenmaid** means Compass Capital Services Pty Ltd ABN 96 138 214 525 trading as Kleenmaid.
  - d. **Mainland Australia** means the following States and Territories of Australia: New South Wales, Victoria, South Australia, Western Australia, Queensland, Tasmania, Northern Territory, Australian Capital Territory.
  - e. **Product** means the appliance sold by Kleenmaid to you as evidenced by the original purchase invoice.
  - f. **Warranty Period** means the period of 60 months for domestic use, 12 months for non-domestic use or such alternative period as may be specified.

**UPDATE NOTICE:** This Kleenmaid Warranty is current as at 1 January 2019 but is subject to variation from time to time. For the latest version of the Kleenmaid Warranty, please see our website <http://www.kleenmaid-appliances.com.au/support/your-kleenmaid-warranty> or phone us on (02) 9310 1207.

## Other products available in the Kleenmaid range of appliances

---

- | Washing machines
- | Clothes dryers
- | Dishwashers
- | Ovens
- | Cooktops
- | Steam ovens
- | Microwave ovens
- | Built in espresso coffee machines
- | Rangehoods
- | Freestanding ovens
- | Refrigerators & Freezers
- | Beverage Serving Cabinets
- | Water Dispensers
- | Vacuum Cleaners

Compass Capital Services Pty Limited  
trading as Kleenmaid  
ABN 96138214525

Level 2, 204 Botany Road Alexandria  
NSW 2015



Register your Kleenmaid Appliances Warranty  
[www.kleenmaidwarranty.com.au](http://www.kleenmaidwarranty.com.au)



Request a Warranty Service  
[www.kleenmaidwarranty.com.au](http://www.kleenmaidwarranty.com.au)

E: [support@kleenmaid.com.au](mailto:support@kleenmaid.com.au)  
[www.kleenmaid.com.au](http://www.kleenmaid.com.au)

 **kleenmaid**