

Cooking Collection

Instructions for Use and Warranty Details

MWK101X
Built in Microwave Oven with Quartz Grill

congratulations

the best you can own.

Congratulations on the purchase of your new Kleenmaid appliance. This appliance has been designed and manufactured to give you years of reliable performance.

the kleenmaid story.

More than one million Australians enjoy using Kleenmaid appliances daily. Selected because of their unique design, outstanding performance, excellent quality and unquestionable reliability, each one is value-for-money, 100 per-cent guaranteed and at the top of its class.

attention to detail.

We are proud of our reputation for product innovation and service excellence. By dealing direct, we can ensure that you consistently receive a high standard of customer service.

Free delivery, dedicated customer service and after-sales service team plus free kitchen design and planning seminars are just a few of the ways we are setting new benchmarks for customer service and experience.

satisfaction guaranteed.

Your new appliance is covered by a written five-year parts and labour warranty, no lemon guarantee, and a unique best value guarantee.

best results.

For best results, carefully read the enclosed instructions on how to install your new appliance. Correct installation will avoid delays and unnecessary service calls.

This booklet provides you with comprehensive information to help you get to know the controls and the features of your new appliance.

Contents

Please read this user manual carefully. It contains important instructions concerning installation, use and security measures.

Installation	4
Warning	7
General description	8
The control Panel	9
Setting the clock / Microwave power settings	10
The display	11
The selector knobs / Programming	12
Microwave programming	13
The Duo Function	14
The grilling racks	16
The grill function / Programming the grill	17
The microwave + grill function / Programming	18
Security / Recommendations	19
Care & cleaning	20
Troubleshooting guide	21
After Sales Service	22

Environmental protection

This appliance's packaging material is recyclable. Help recycle it and protect the environment by dropping it off in the municipal receptacles provided for this purpose.



Your appliance also contains a great amount of recyclable material. It is marked with this label to indicate the used appliances that should not be mixed with other waste. This way, the appliance recycling organised by your manufacturer will be done under the best possible conditions, in compliance with European Directive 2002/96/EC on Waste Electrical and Electronic Equipment. Contact your town hall or your retailer for the used appliance collection points closest to your home.

We thank you for doing your part to protect the environment.

Installation

BEFORE CONNECTION

- **Check whether your oven has suffered any damage during transport (deformed door or door seal, etc.). If you see any signs of damage, contact Kleenmaid before use.**
- Verify the power voltage. If there is a PERMANENT undervoltage (200-210 volts), consult your electrical installer.

LOCATION

- According to the model, the microwave oven must be built in or set on a work surface at least 850 mm above floor level.
- Place the oven on a flat and horizontal surface, away from any source of heat or steam.
- Make sure that air may circulate freely around the oven.
- Allow nothing to obstruct the ventilation louvers at the back of the appliance.
- Make sure the electrical plug will be accessible after installation.

ELECTRICAL CONNECTION

- **Your installation must be protected by a 15 Amp thermal fuse.**
- It is mandatory to use a power point with **an earthed power point**, connected in accordance with current safety regulations.
- In your electrical installation, provide a device that is accessible to the installer, capable of separating the appliance from the mains power and whose contact opening is at least 3 mm at all of the poles.
- Never operate the oven if the supply cord and/ or its plug are damaged. **In case of damage, call in a qualified technician trained by the manufacturer.**

Building-in

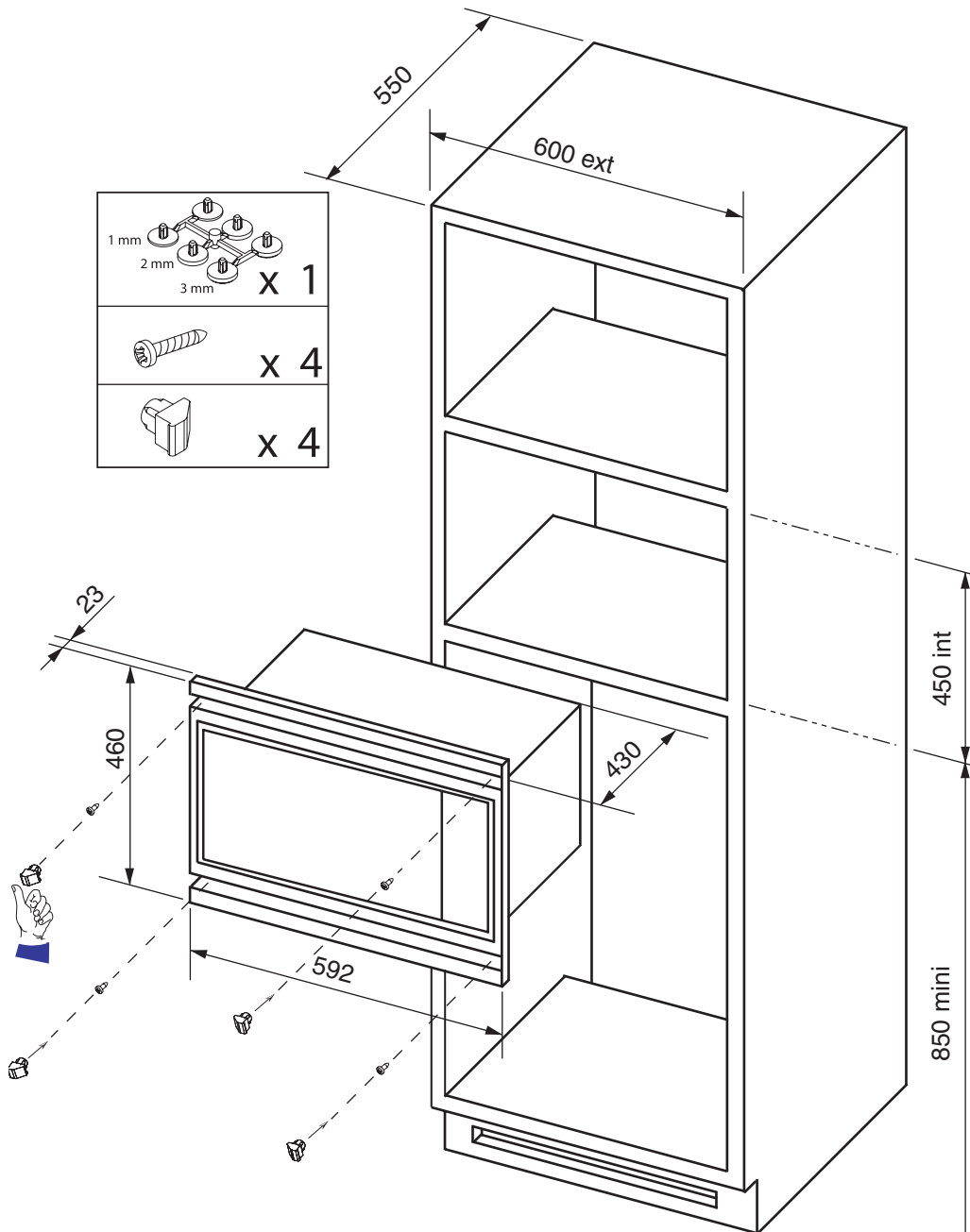

Building-in

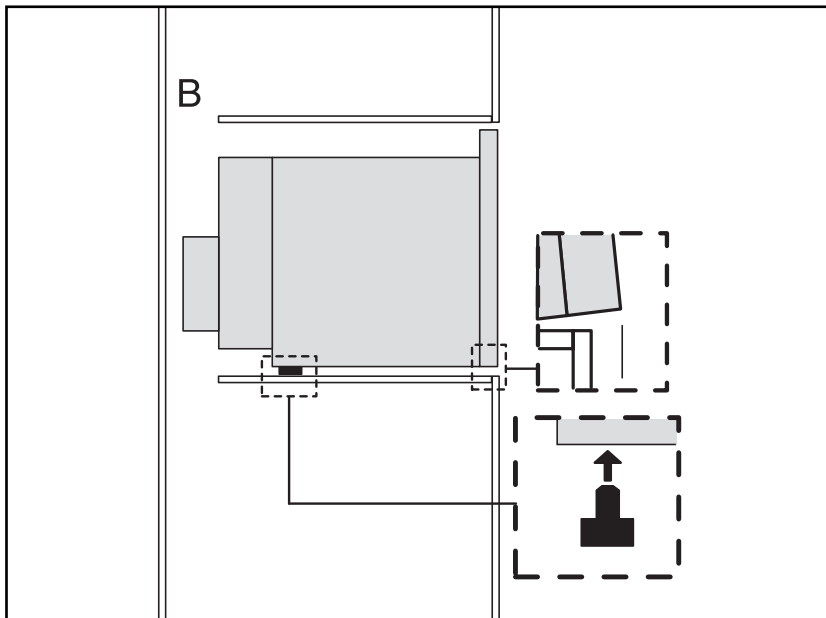
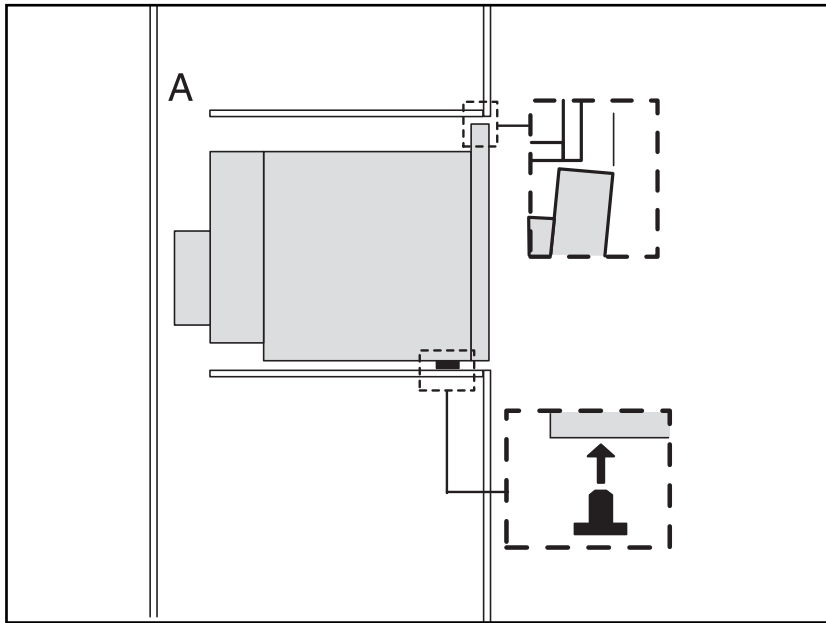

Warning

- Your appliance is designed exclusively for the domestic purposes of defrosting, heating or cooking foods. The manufacturer bears no responsibility in the case of improper usage.
- Only use utensils that are suitable for use in microwave ovens.
- To avoid deterioration of your microwave oven, never operate it empty or without the turntable.
- Never tamper with the lock mechanism of your microwave oven; you could cause damage requiring repair by an authorised technician.
- When heating food in plastic or paper containers, keep an eye on the oven due to the possibility of ignition.
- It is not advisable to use metal recipients, forks, spoons, knives, metal ties or staples for deep-freeze bags.
- The contents of feeding bottles or baby food jars shall be stirred or shaken and the temperature checked before consumption in order to avoid burns.
- Only allow children to use the oven without supervision when adequate instructions have been given so that the child is able to use the oven in a safe way and understands the hazards of improper use.
- Liquids and other foods must not be heated in sealed containers they are liable to explode.
- Eggs in their shell and whole hard-boiled eggs should not be heated in microwave ovens since they may explode, even after microwave heating has ended.
- Microwave heating of beverages can result in delayed eruptive boiling, therefore care must be taken when handling the container.
- For small amounts (one sausage, a single croissant, etc.), place a glass of water alongside the food item.
- Time settings that are too long may dry out and burn the food. To avoid such incidents, never use the same cooking times as those recommended for traditional ovens.
- If smoke is observed, switch off or unplug the appliance and keep the door closed in order to stifle any flames.
- The appliance is not intended for use by young children or infirm persons without supervision.
- Young children should be supervised to ensure that they do not play with the appliance.

General description

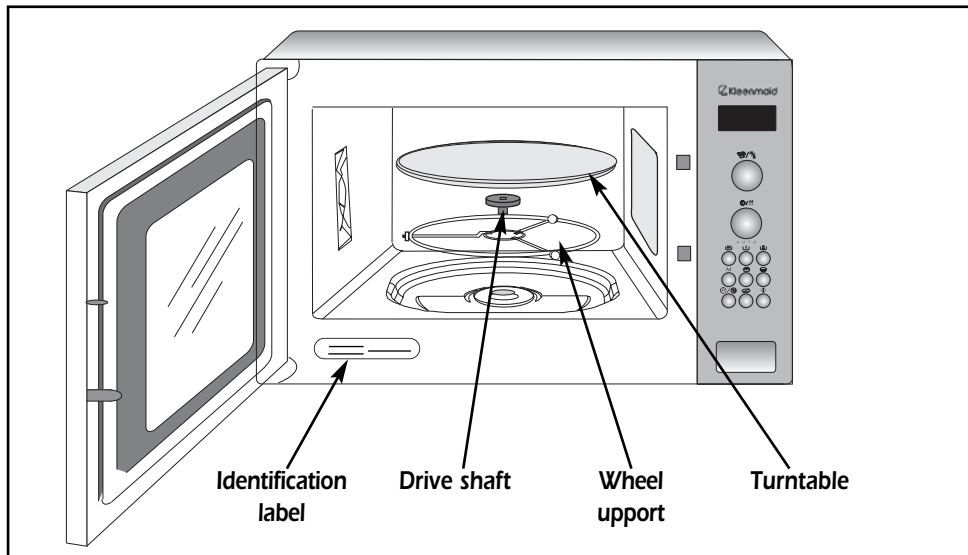

■ THE TURNTABLE :

ensures equal cooking of food throughout with no need to stir or turn the dish.

- It may be used as a cooking platter.
- Rotation is controlled by the drive shaft and the wheel support.
- The turntable revolves in both directions.
- If it does not turn, verify that all components are properly positioned.
- For easy removal, wells are provided on either side.









■ TURNTABLE OFF :

stops the turntable from revolving in order to use platters which require the entire oven space.

■ THE WHEEL SUPPORT :

Do not try to rotate the roller ring manually, as you could damage the drive system. If it does not turn smoothly, make sure that there is nothing in the well beneath the turntable.

The control panel

- A Display window :**
to simplify programming, the display indicates : the time of day, the types of food and functions, the the minutes / seconds or weight programmed .
- B The selector knob**  :
to choose the food type or function.
- C The selector knob**  :
to choose the programme time or weight.
- D-E-F The "A U T O " keys**  :
automatically set the appropriate programme time according to the weight and the selected food type.
- G The MODE key M:**
to choose the appropriate function, with the selector knob  .
- H The GRILL key**  :
to directly programme the grill function.
- I The DUO key**  :
for dual level reheating; to be used with the steam effect plate stackers.
- J The PAUSE/CANCEL key**  :
to interrupt (press once) or cancel a programme (press twice).
Also used to set the clock.
- K STOP-TURNTABLE key**  :
to stop the turntable from revolving.
- L START key**  :
to start all programmes.
- M DOOR OPEN button :**
press this button to open the door or stop the appliance.

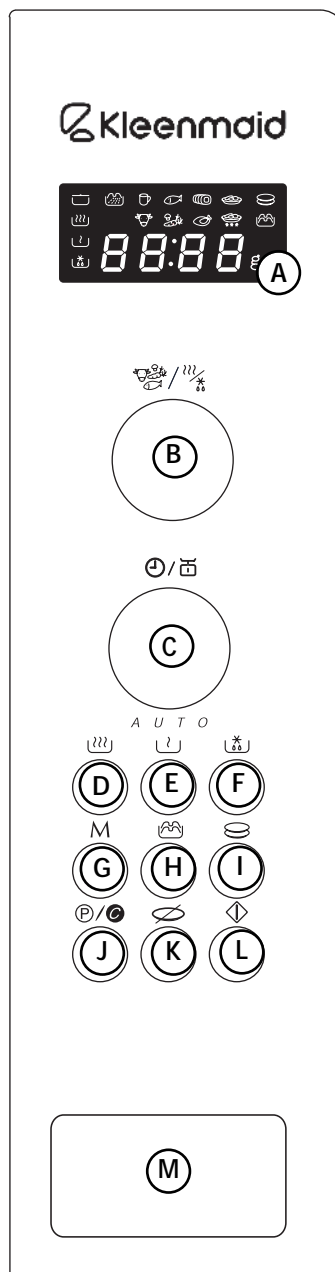

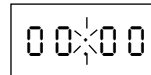

Setting the clock

After first plugging in your microwave oven or after a power outage, the clock reads 00:00 and the two dots flash.





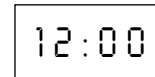
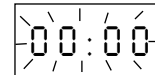

To set the clock :

- Press the **PAUSE / CANCEL** key  for 5 seconds.
"00:00" flashes, and a tone sounds requesting the hour be set.
- Turn the selector knob to display the correct time.
- Validate by pressing the **PAUSE / CANCEL** key .



Your clock is set.

Microwave power settings

POWER SETTING	APPLICATION
 DEFROST	To defrost all frozen food or to top off cooking of delicate dishes or to cook very slowly.
 SIMMER	To finish programmes begun with the HIGH COOK power setting, for instance beans, lentils, or dairy products. (This power setting is available when you programme the function using the mode M key.)
 HEAT	To heat up all liquids and all fresh or frozen pre-cooked dishes.
 HIGH COOK	To cook vegetables, fish, poultry and soup.
Microwave output power : 900 W	

When you select the type of food, the appropriate power setting is automatically programmed.

The display



The display and the selector knobs guide you in your choice of :

les aliments

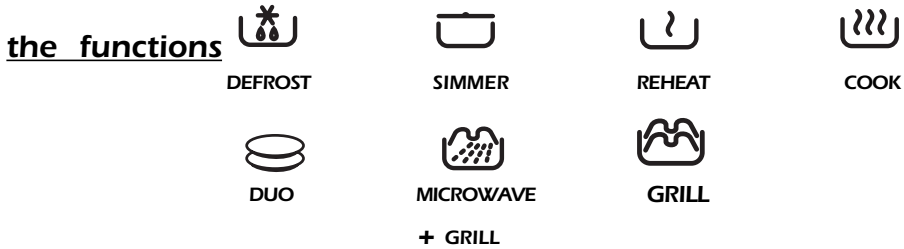

the weight for an **AUTO** programme

the length of the programme (or time of day) 12:00

The food type or function being selected will flash in the display.

The selector knobs

The 2 selector knobs are used for the various programmes:

The first to select

- the food type



- the function

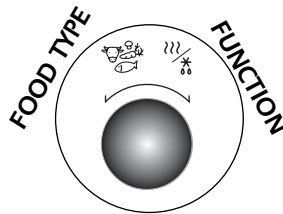

the second to programme

- the length of the programme



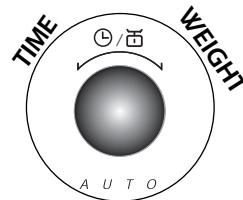

- the weight of the food



Programming

Your microwave oven is now plugged in and the clock is set.



Open the door. Set the dish inside, close the door. If the door is not properly shut, the appliance will not operate.

- 3 beeps announce the end of a programme. The beeps are repeated every minute for 10 minutes until you open the door.
- If you think there is insufficient space for the dish to turn freely inside the oven, press the **STOP TURNTABLE** key  before or during the programme. (you may not stop the turntable during a programme using the Duo function).
- If there is an error in the programming, press the **CANCEL** key   twice.

Microwave programming

Available programmes :

Express programming







- ▼ Set the desired programme length (ex. 2 minutes) with the selector knob .
- ▼ Press start . The maximum power setting  is programmed directly for quick reheating.

2:00



Automatic programming by weight :

with the **A U T O** keys, the programme length is calculated automatically.

- ▼ Choose the food type with the selector knob  (ex. fish).
- ▼ Press one of the microwaving keys ,  or  (ex. COOK ) or press the **M** key and choose your function with the selector knob . Press the **M** key again.

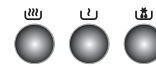





- ▼ 50g blinks; programme the weight of your food item using the selector knob  (ex. 500 g).

500g

- ▼ Press start . The appropriate power level is programmed, the adequate programme length is displayed automatically (ex. 7 min) and the programme begins.

7:00

Automatic programming by food type

- ▼ Choose your food type with the selector knob , (ex. fresh ready-made dishes .
- ▼ Press the **M** key, choose your function with the selector knob  (ex. HEAT ); the appropriate microwave power setting for that food item is programmed automatically.





- ▼ Set the desired programme length (ex. 7 min) with the selector knob .

7:00

- ▼ Press start .

Automatic programming by function

- ▼ Press the **MODE M** key, choose the desired function with the selector knob . The **SIMMER** function  is available in this programme.



- ▼ Set the desired programme length (ex. 5 minutes), with the selector knob .

5:00

- ▼ Press start .

The DUO function : dual level reheating

- ☉ **The DUO function enables you to heat up two plates at the same time**, all the while retaining full flavor due to the steam effect provided by the Duo plate stackers.

Just cover the plates, stack them one on top of the other, and place together on the center of the turntable.

- ☉ Use the Duo button  together with the Duo plate stackers.

- ☉ **The advantages of the plate stackers :**

- Food retains full flavour due to the steam effect.
- Dishes are heated evenly throughout.
- Drying out of food is minimized.
- Programme time can be reduced.
- By preventing splattering, they help keep your oven clean .

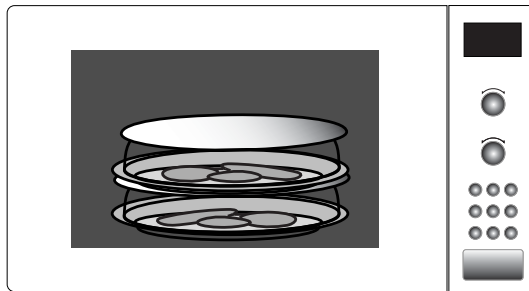

- ☉ The Duo function can be used to heat up fresh or refrigerated dishes. Neither the defrosting or heating of **frozen** products nor the **cooking** of dishes is recommended.

- ☉ **Care of your Duo plate stackers :**

- A sponge, hot water and liquid detergent are all you need to clean your plate stackers. Do not use a metal scouring pad or scouring powder.
- The Duo plate stackers are dishwasher-safe.

- ☉ **Do not use the DUO plate stackers with the grill or microwave + grill functions as this could cause them irremediable damage.**

The DUO function : dual level reheating

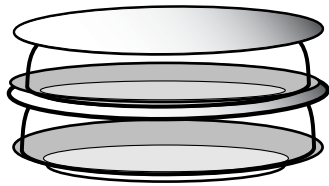

The DUO plate stackers





The Duo plate stackers with steam action :

2 plate stackers so that you can heat up 2 fresh or refrigerated dishes at the same time.

 **Example** : Heating up 2 plates of ravioli = 5 min.

- Cover the two plates with the Double Decker plate stackers, and place in the center of the turntable.
- Press the Duo key  , 00:00 flashes,  is displayed.

Set the time with the selector knob  , ex. 5 minutes : 05:00 is displayed.
Press start  , the Duo reheating function begins.

As a general rule :

- For a homogenous dish such as mashed potatoes, peas, celery etc. :
2 plates of 200 g 3 / 4 min
- For a mixed consistency dish such as franks and beans, beef bourguignon, ravioli, etc. :
2 plates of 300 g 5 / 6 min

The times indicated below are based on heating of refrigerated dishes, or room temperature for canned goods.

The grilling racks

Make sure that the rack is always well centered on the turntable.

Never use any metal dish with the rack with the microwave, grill + microwave or fan + microwave functions.

Nevertheless you may heat up food in an aluminium tray if you place a plate between the tray and the rack.

The rack :

to brown low dishes with the grill
or microwave + grill functions

The rack

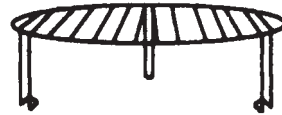





The grill function

This function enables you to brown dishes such as gratins or meat. It may be used before or after cooking, as called for in the recipe.

- According to the food item you wish to grill, you may either set the dish on the rack or directly on the turntable.
- After grilling make sure to use an oven mitt to handle dishes, and remember to use only ovenproof cookware such as ceramic dishes or heat resistant glass. Always allow the grill to cool off 25 minutes before touching it.
- **WARNING** : certain exposed parts may heat up during use of the grill. Be sure to keep children away.

Programming the grill

Using the single grill

- ▼ Press the grill key , or press the **M** key, choose the **GRILL** function  with the selector knob .
- ▼ Set the desired programme length with the selector knob,  and press start .

The microwave + grill function









This function enables you to use the microwaves and grill **simultaneously**, for rapid cooking.



Automatic programming by the weight :

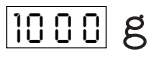

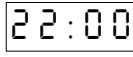



you enter only the weight of the food item and programming is automatic

- ▼ Choose the desired food type with the selector knob  ex. poultry. 
- ▼ Press the **M** key. Select the microwave + grill function  with the selector knob . The microwave power level and the grill level are automatically adapted to your dish.
- ▼ Press the **M** key, 50g flashes; programme the weight of your food item with the selector knob  ex. 1000 g. 
- ▼ Press start ; the suitable time is displayed (ex. 22 min) and the programme begins. 



Automatic programming by the food type :

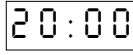



with the **M** key

- ▼ Choose your food type amongst the available categories with the selector knob , ex. turkey roast. 
- ▼ Press the **M** key, and then select the microwave + grill function with the selector knob . The microwave power level as well as the grill level are automatically adapted to your dish. 
- ▼ Set the programme length with the selector knob , ex. 20 min. 
- ▼ Press start .



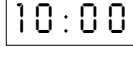

Programming by function :

with the **M** key

- ▼ If your food item does not correspond to any of the available categories, select the microwave + grill function with the **M** key. An intermediate microwave power level together with the grill are programmed. 
- ▼ Set the programme length with the selector knob , ex. 10 min. 
- ▼ Press start .







Security

If after having entered a programme and closed the door you wait longer than 30 seconds before pressing the **START** key , the oven will not operate and the message **S E C U** will appear in the display window, to prevent start-up of an empty oven.

In order for the oven to operate, open and then close the door and press the **START** key. Otherwise, press the **CANCEL** key  and reprogramme.

Recommendations

WHILE THE OVEN IS OPERATING :

- You may stop or start the turntable revolving during a programme by pressing the **TURNTABLE STOP** key  (except with the Duo function).
- To change the food type or function selection, press the **CANCEL** key  twice and programme again.
- If you open the door before the end of the programme, shut the door and press the **START** key  to continue the programme.
- When using the defrost function , a beep indicates the mid-point of the programme (the oven continues to operate); to obtain the best results, turn the food at this time, close the door and press the **START** key  to continue the second half of the programme.
- If you remove a dish before the end of the programme, press the **CANCEL** key  twice to erase the programme.

REMARKS :

- If you wait longer than 3 minutes to press the **START** key  after having entered a programme, it will be cancelled (the clocktime will be displayed).

Care & cleaning

- **WARNING** : It is recommended to clear the oven regularly and to take any food deposit inside and outside the appliance. Use a soapy and wet cloth. If the appliance is not kept clean, its surface could deteriorate and adversely affect its life and possibly result in a hazardous situation. If the door or door seals are damaged, the oven must not be operated until it has been repaired by a competent person.



- A steam cleaner is not to be used.

- Do not use abrasives, alcohol or solvents as they are liable to damage the oven.

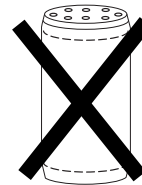
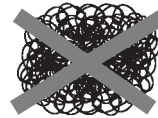

- In the event of unsavory odors or caked-on dirt, boil water containing lemon juice or vinegar in a cup for 2 minutes and clean the walls with a little dishwashing liquid.
- For those ovens with grill or convection heat functions, the top and rear air vents become very hot. Do not touch these parts after use; wait till the appliance has cooled down in order to clean it. Use a fine steel wool pad on the metal parts.

- The turntable can be removed for cleaning. Wells are provided on both sides for easy access.

If you remove the drive shaft, do not allow water to enter the motor shaft hole.

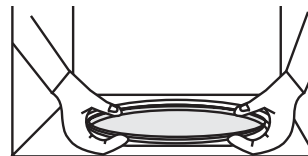



Be sure to put the turntable, the drive shaft and the wheel support back in their proper place.

Troubleshooting guide

Problem

Suggestion

- | | |
|--|--|
| <p>▼ The message "SEU" is displayed.</p> | <p>▲ Cancel the security : open then shut the door and press the START key .</p> |
| <p>▼ The time counts down, but the appliance does not function (the turntable does not rotate, the light does not come on and the food is not heated).</p> | <p>▲ Press the TURNTABLE OFF key  for 5 seconds.</p> |
| <p>▼ The microwave oven is noisy when operating.</p> | <p>▲ Adjust the front left foot.
Clean the wheels and the well area beneath the turntable.</p> |
| <p>▼ Condensation forms on the door glass.</p> | <p>▲ Wipe the water off with the help of a cloth in order to avoid.</p> |
| <p>▼ The grill element smokes when heating up.</p> | <p>▲ Clean all cooking residue from the grill element.</p> |
| <p>▼ The turntable does not revolve correctly.</p> | <p>▲ Clean the wheels and the well beneath the turntable.</p> |
| <p>▼ The microwave programmes do not produce the desired results.</p> | <p>▲ Clean the vents under the appliance.
Make sure that you use only containers which are suitable for microwave cooking.</p> |
| <p>▼ The appliance produces sparks.</p> | <p>▲ Check whether the wheel support is correctly positioned.
Thoroughly clean the appliance : remove any greasy deposits, cooking residue, etc...
Move any metal objects away from the oven walls.
Never use metallic containers with a rack.</p> |

After-sales service

- If the equipment has sustained any damage :
 - **Check that the door is not deformed.**
- If the oven does not operate, before calling the repairman :
 - Check the electrical supply.
 - Check that the door is properly closed.
 - Check your programming.

**CAUTION : never attempt to repair
your oven yourself.**

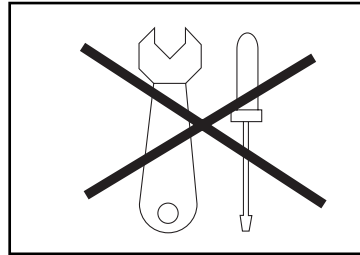

WARNING : it is dangerous for anyone other than qualified personnel to make any repairs requiring removal of the cover providing protection from exposure to microwave energy.

**Only a specially trained technician is qualified
to repair your microwave oven.**

appliances available in the Kleenmaid range

the best products we can find.

We search the globe for products that meet our high standards of functionality, style and quality and are proud of our innovative range sourced from countries throughout the world.

Washing Machines
Dryers
Dishwashers
Ovens
Cooktops
Outdoor Cooking Centres
Built-In Coffee Machines
Rangehoods
Freestanding Ovens and Cooktops
Sinks
Waste Disposals
Taps
Cookware
Refrigerators
Wine Cellars
Vacuum Cleaners

To find your nearest Kleenmaid Showroom
telephone 13 13 08.

 **Kleenmaid**
The best you can own.